

Monitoring and Control Devices



7/2	Introduction	
7/5	SIMOCODE 3UF Motor Management and Control Devices	7/102 7/105 7/108 Ch. 6
7/26	SIMOCODE pro 3UF7 motor management and control devices	
7/26	SIMOCODE-DP 3UF5 motor protection and control devices	
7/35	3UF18 current transformers for overload protection	
7/40	3UL22 summation current transformers	
7/41	LOGO! Logic Modules	
7/42	General data	
7/43	LOGO! Modular basic variants	
7/43	LOGO! Modular pure variants	
IK PI ¹⁾	LOGO! Modular extension modules	
IK PI ¹⁾	LOGO! Modular communications modules	
IK PI ¹⁾	AS-Interface connection for LOGO!	
IK PI ¹⁾	LOGO!Contact	
7/44	LOGO! Software	
7/45	3RP, 7PV Timing Relays	
7/49	General data	
7/49	3RP15 timing relays in industrial enclosure, 22.5 mm	
7/55	3RP20 timing relays, 45 mm	
7/58	7PV timing relays for panel mounting	
7/60	3RT19 timing relays for mounting to contactors	
7/63	Monitoring Relays	
7/69	<u>3UG Monitoring Relays for Electrical and Additional Measurements</u>	
7/73	Line monitoring	
7/76	Voltage monitoring	
7/76	Current monitoring	
7/78	Power factor monitoring	
7/80	Insulation monitoring for ungrounded AC networks	
7/82	Insulation monitoring for ungrounded DC networks	
7/85	Level monitoring	
7/85	Speed monitoring	
7/87	<u>3RS10, 3RS11 Temperature Monitoring Relays</u>	
7/90	General data	
7/92	Relays, analog adjustable	
7/94	Relays, digitally adjustable to DIN 3440	
7/96	Relays, digitally adjustable for up to 3 sensors	
7/96	<u>3RN1 Thermistor Motor Protection</u> For PTC sensors	
	3TK28 Safety Relays	
	With electronic enabling circuits	
	With relay enabling circuits	
	With contactor relay enabling circuits	
	3RA71 load feeders with integrated safety functions	
	Interface Converters	
	3RS17 interface converters	
	1) See Catalog IK PI · 2005 "Industrial Communication for Automation and Drives"	



Introduction

Overview

The advantages at a glance



3UF7



3UF5



6ED1 052

SIMOCODE 3UF motor management and control devices

SIMOCODE pro 3UF7

- Compact, modular design
- Unique flexibility in terms of functionality and hardware configuration
- Wide functional range from the distributed I/O system to the autonomous motor management system
- All control functions from the direct starter to the pole-changing switch with reversing contactor
- All motor sizes
- Integration in all PROFIBUS-capable automation systems
- Application in low-voltage controlgear for motor control centers on the process industry
- Increases plant availability
- Saves costs during construction, commissioning and operation of the plant
- Extensive data of the motor feeder available everywhere on the PROFIBUS
- All protection, monitoring and control functions for the motor feeder in a single system

Order No.	Page
-----------	------

3UF7	7/5
3UF5	7/26

SIMOCODE-DP 3UF5

3UF18 current transformers for overload protection

- Protection converter for activating overload relays or for use with SIMOCODE pro
- Ensures proportional current transfer up to a multiple of the primary rated current

3UF18	7/35
-------	------

3UL22 summation current transformers

- Senses fault currents in machines and plants
- Senses ground fault currents

3UL22	7/40
-------	------

LOGO! logic modules

LOGO! logic modules

- Compact, user-friendly and low-cost solution for simple control tasks
- Universal:
 - Building installation and wiring (lighting, shutters, awnings, doors, access control, barriers, ventilation systems ...)
 - Control cabinet installation
 - Machine and device construction (pumps, small presses, compressors, hydraulic lifts, conveyors ...)
 - Special controls for conservatories and greenhouses
 - Signal preprocessing for other controllers
- Flexible expansion depending on the application

LOGO! Modular basic variants

- With display, pushbuttons and an interface for connecting extension modules

6ED1 052-1	7/42
------------	------

LOGO! Modular pure variants

- Without display and pushbuttons but with an interface for connecting extension modules

6ED1 052-2	7/43
------------	------

LOGO! Modular extension modules

- For connection to LOGO! Modular basic variants with digital inputs and outputs or analog inputs and outputs

6ED1 055-1	IK PI ¹⁾
------------	---------------------

LOGO! Modular communications modules

- For integrating LOGO! in an *instabus* KNX *EIB* system or as an AS-Interface slave

3RK1 400	IK PI ¹⁾
----------	---------------------

LOGO!Power

- Power supply for converting the supply voltage of 100 ... 240 V AC into an operational voltage of 24 V DC or 12 V DC

6EP1 3	IK PI ¹⁾
--------	---------------------

LOGO!Contact

- Switching module for switching resistive loads and motors directly

6ED1 057-4	IK PI ¹⁾
------------	---------------------

LOGO! Software

- For switchgear program generation on the PC

6ED1 058	7/44
----------	------

1) See Catalog IK PI · 2005 "Industrial Communication for Automation and Drives"

The advantages at a glance



3RP



7PV



3UG45 11



3UG46 14

		Order No.	Page
3RP, 7PV timing relays			
3RP15 timing relays in industrial enclosure, 22.5 mm	<ul style="list-style-type: none"> • Low-cost solution with monofunctions such as response delay, off-delay, clock-pulse, wye-delta function and multifunction • Wide-range voltage designs 	3RP15	7/49
3RP20 timing relays, 45 mm	<ul style="list-style-type: none"> • The solution for small mounting depths • The low mounting height reduces the tier spacing 	3RP20	7/55
7PV timing relays for panel mounting	<ul style="list-style-type: none"> • Digital variant 	7PV	7/58
3RT19 timing relays for mounting onto contactors	<ul style="list-style-type: none"> • Saves space because the relay is mounted onto the contactor • Wiring advantages thanks to direct contacting with contactor 	3RT19	7/60
3UG monitoring relays for electrical and additional measurements			
<i>Line monitoring</i>			
Phase sequence	<ul style="list-style-type: none"> • Low-cost solution for monitoring the phase sequence 	3UG45 11	7/63
Phase sequence, phase failure, phase unbalance	<ul style="list-style-type: none"> • Wide voltage range from 160 ... 690 V 	3UG45 12	7/63
Phase sequence, phase failure, phase unbalance and undervoltage	<ul style="list-style-type: none"> • Analog adjustable • Wide voltage range from 160 ... 690 V 	3UG45 13	7/64
	<ul style="list-style-type: none"> • Digitally adjustable with LCD display for indication of ACTUAL value and device status • Wide voltage range from 160 ... 690 V 	3UG46 14	7/64
Phase sequence, phase failure, phase unbalance and overvoltage and undervoltage	<ul style="list-style-type: none"> • Digitally adjustable with LCD display for indication of ACTUAL value and device status • Wide voltage range from 160 ... 690 V 	3UG46 15	7/65
Phase sequence, phase and N conductor failure, phase unbalance, overvoltage and undervoltage		3UG46 16	7/65
Automatic correction of the direction of rotation in case of wrong phase sequence, phase failure, phase unbalance, overvoltage and undervoltage		3UG46 17	7/65
Automatic correction of the direction of rotation in case of wrong phase sequence, phase and N conductor failure, phase unbalance, overvoltage and undervoltage		3UG46 18	7/65
<i>Voltage monitoring</i>			
Voltage monitoring with internal power supply for overvoltage and undervoltage	<ul style="list-style-type: none"> • Digitally adjustable with LCD display for indication of ACTUAL value and device status • Wide measuring ranges • Variant for wide voltage range 	3UG46 33	7/69
Voltage monitoring with auxiliary voltage for overvoltage and undervoltage		3UG46 31/32	7/70
<i>Current monitoring</i>			
Current monitoring with auxiliary voltage for overvoltage and undervoltage	<ul style="list-style-type: none"> • Digitally adjustable with LCD display for indication of ACTUAL value and device status • Wide measuring ranges • Variant for wide voltage range 	3UG46 21/22	7/73
<i>Power factor monitoring (motor load monitoring)</i>			
Monitoring relay for overshoot and undershoot monitoring with internal power supply (window monitoring)	<ul style="list-style-type: none"> • Upper and lower threshold value can be adjusted separately 	3UG30 14	7/76
<i>Insulation resistance</i>			
Monitoring of the insulation resistance for ungrounded AC or DC networks from 10 ... 110 kΩ	<ul style="list-style-type: none"> • Test button • With or without memory • Switchable measuring range 	3UG30 81, 3UG30 82	7/78
<i>Level monitoring</i>			
Fill level and resistance	<ul style="list-style-type: none"> • As single-step or two-step controls for inlet or outlet monitoring of conducting liquids or as resistance threshold switch • Variable, wide range from 5 ... 100 kΩ • UNDER/OVER adjustable 	3UG35 01	7/82
<i>Speed monitoring</i>			
Underspeed monitoring	<ul style="list-style-type: none"> • Together with a sensor for monitoring continuous pulses • With or without memory • Adjustable ON delay • 1, 2 and 3 changeover contacts • Hard gold-plated contacts in combination and wide voltage range versions 	3UG30 51	7/85



Introduction

The advantages at a glance



3RS10



3RN1



3TK28



3RS17

	Order No.	Page
3RS10, 3RS11, 3RS20 temperature monitoring relays		
<i>For monitoring the temperatures of solids, liquids, and gases</i>		
Relays, analog adjustable	<ul style="list-style-type: none"> • Separate versions for overshoot and undershoot • For simple monitoring tasks • For PT100 or thermoelements J and K • Variable hysteresis 	3RS10, 3RS11 7/90
Relays, digitally adjustable acc. to DIN 3440	<ul style="list-style-type: none"> • For two-step or three-step controls • For monitoring heat generation plants • For PT100/1000, KTY83/84, NTC or thermoelements type J, K, T, E, N, R, S, B 	3RS10, 3RS11, 3RS20 7/92
Relays, digitally adjustable for up to 3 sensors	<ul style="list-style-type: none"> • For simultaneously monitoring several sensors • Especially suited for monitoring motor winding temperatures • For PT100/1000, KTY83/84, NTC 	3RS10 7/94
3RN1 thermistor motor protection		
For PTC sensors	<ul style="list-style-type: none"> • Relays for monitoring motor winding temperatures with type A PTC sensors • Integrated with ATEX license • Closed-circuit principle • Depending on the version: With short-circuit and open-circuit detection, zero voltage safety, manual/auto/remote RESET, 1 CO, 1 NO + 1 NC, 2 CO, 1 NO + 1 CO or 2 CO hard gold-plated 	3RN1 7/96
3TK28 safety relays		
With electronic enabling circuits	<ul style="list-style-type: none"> • Permanent function checking • No wear because switched electronically • High switching frequency • Long electrical endurance • Evaluation of solid-state sensors • Sensor lead up to max. 2000 m • Cascading possible • Insensitive to vibrations and dirt • Compact design, low weight • Approved for the world market 	3TK28 4 7/102
With relay enabling circuits	<ul style="list-style-type: none"> • Compact design • Floating safe outputs • Also suitable for press and punch controls • Can be used up to an ambient temperature of max. 70 °C 	3TK28 2, 3TK28 3 7/105
With contactor relay enabling circuits	<ul style="list-style-type: none"> • Floating enabling circuits • AC-15/DC-13 switching capacity • Safe isolation • Long mechanical and electrical endurance • Certified as a complete unit • Fault minimization and cost reduction through factory wiring • Low installation costs 	3TK28 5 7/108
3RA71 load feeders with integrated safety functions	<ul style="list-style-type: none"> • Available in fused or fuseless configuration • Floating enabling circuits • AC-1/AC-3 switching capacity • Certified as a complete unit • Long mechanical and electrical endurance • Rated operational voltage up to 690 V • Safe isolation 	3TK28 5 Ch. 6
3RS17 interface converters		
Converters for standard signals and non-standard variables	<ul style="list-style-type: none"> • All terminals protected against polarity reversing and overvoltage up to 30 V • For electrical isolation and conversion of analog signals • Short-circuit resistant outputs • From 6.2 mm width • Switchable multi-range converters • Variants with manual/automatic switch for setpoint input or for the conversion of analog variables into frequency 	3RS17 7/112

Overview

SIMOCODE pro is a flexible, modular motor management system for motors with constant speeds in the low-voltage performance range. It optimizes the connection between I&C and motor feeder, increases plant availability and allows significant savings to be made for startup, operation and maintenance of a system.

When SIMOCODE pro is installed in the low-voltage switchgear cabinet, it is the intelligent interface between the higher-level automation system and the motor feeder and includes the following:

- Multifunctional, solid-state full motor protection which is independent of the automation system
- Flexible software instead of hardware for the motor control
- Detailed operational, service and diagnostics data
- Open communication through PROFIBUS DP, the standard for fieldbus systems

Design

General

SIMOCODE pro is a modularly constructed motor management system which is subdivided into two device series with different functional scopes:

- SIMOCODE pro C
- SIMOCODE pro V

Both series (systems) are made up of different hardware components (modules):

System	SIMOCODE pro C	SIMOCODE pro V
Modules	<ul style="list-style-type: none"> • Basic unit 1 • Current measuring module • Operator panel (optional) 	<ul style="list-style-type: none"> • Basic unit 2 • Current measuring module or current/voltage measuring voltage • Operator panel (optional) • Expansion modules (optional)

Per feeder each system always comprises one basic unit and one separate current measuring module. The two modules are connected together electrically through the system interface with a connection cable and can be mounted mechanically connected as a unit (one behind the other) or separately (side by side). The motor current to be monitored is decisive only for the choice of current measuring module.

An operator panel for mounting in the control cabinet door is optionally connectable through a second system interface on the basic unit. Both the current measurement module and the operator panel are electrically supplied by the basic unit through the connection cable. More inputs, outputs and functions can be added to basic unit 2 (SIMOCODE pro V) by means of optional expansion modules, thus supplementing the inputs and outputs already existing on the basic unit.

All modules are connected together by connection cables. The connection cables are available in various lengths. The maximum distance between the modules (e.g. between the basic unit and the current measurement module) must not exceed 2 m. The total length of all the connection cables in a single system must not be more than 3 m.

SIMOCODE pro designed for mixed operation

Depending on functional requirements, the two systems can be used simultaneously without any problems and without any additional outlay in a low-voltage system. SIMOCODE pro C is fully upward-compatible to SIMOCODE pro V. The same components are used. The parameterization of SIMOCODE pro C can be transferred without any problems. Both systems have the same removable terminals and the same terminal designations.

SIMOCODE 3UF Motor Management and Control Devices

SIMOCODE pro 3UF7 motor management and control devices

SIMOCODE pro C, basic unit 1

The compact system for

- Direct-on-line and reversing starters
- Actuation of a circuit-breaker (MCCB) with up to 4 binary inputs, up to 3 monostable relay outputs and one thermistor connection (binary PTC)

The basic unit 1 is available in two different variants for the following supply voltages:

- 24 V DC
- 110 ... 240 V AC/DC



SIMOCODE pro C, basic unit 1

Inputs:

- 4 binary inputs, with internal supply from 24 V DC

Outputs:

- 3 (2+1) monostable relay outputs

Thermistor connection for binary PTC

PROFIBUS interface:

- 9-pole SUB-D or
- Terminal connection

Connection of the supply voltage:

- 24 V DC or
- 110 ... 240 V AC/DC

Test/Reset button

3 LEDs

2 system interfaces for connection of

- a current measuring module and
- an operator panel

Basic unit 1 is suitable for standard rail mounting or, with additional push-in lugs, for fixing to a mounting plate.

SIMOCODE pro V, basic unit 2

The variable system which offers all SIMOCODE pro C functions plus many additional functions. Basic unit 2 supports the following control functions:

- Direct-on-line and reversing starters
- Star/delta starters, also with direction reversal
- Two speeds, motors with separate windings (pole-changing switch); also with direction reversal
- Two speeds, motors with separate Dahlander windings (also with direction reversal)
- Slide control
- Solenoid valve actuation
- Actuation of a circuit-breaker (MCCB)
- Soft starter actuation (also with direction reversal)

Basic unit 2 has 4 binary inputs, 3 monostable relay outputs and one thermistor connection (binary PTC). The type and number of inputs and outputs can be increased by means of additional expansion modules.

Basic unit 2 is available in two different variants for the following supply voltages:

- 24 V DC
- 110 ... 240 V AC/DC



SIMOCODE pro V, basic unit 2

Inputs:

- 4 binary inputs, with internal supply from 24 V DC

Outputs:

- 3 (2+1) monostable relay outputs

Thermistor connection for binary PTC

PROFIBUS interface:

- 9-pole SUB-D or
- Terminal connection

Connection of the supply voltage:

- 24 V DC or
- 110 ... 240 V AC/DC

Test/Reset button

3 LEDs

- 2 system interfaces for connection of
- a current measuring module or current/voltage measuring module
 - expansion modules and
 - an operator panel

Basic unit 2 is suitable for standard rail mounting or, with additional push-in lugs, for fixing to a mounting plate.

Current measuring modules (current ranges)

The current measurement module is selected for each feeder according to the rated motor current to be monitored. Various current measurement modules for current ranges from 0.3 to 630 A are available for this purpose. The current measurement module is connected to the basic unit by a connection cable and is supplied with electricity by the basic unit through this connection cable. Current measurement modules up to 100 A are suitable for standard rail mounting or can be fixed directly to the mounting plate by means of additional push-in lugs. Similarly, current measurement modules up to 200 A can also be mounted on standard mounting rails or be fixed directly to mounting plates by means of fixtures integrated in the housing. Finally, current measuring modules up to 630 A can only be mounted with the integrated screw fixtures.

Note:
Current measuring modules for up to 100 A set current can be mechanically connected to the corresponding basic unit and mounted with it as a unit (one behind the other). For larger current measuring modules, only separate mounting is possible.

Current measuring modules for the following current ranges are offered:









- 0.3 ... 3 A with straight-through current transformer
- 2.4 ... 25 A with straight-through current transformer
- 10 ... 100 A with straight-through current transformer
- 20 ... 200 A with straight-through current transformer or busbar connection
- 63 ... 630 A with busbar connection

For motor currents up to 820 A, a current measuring module for 0.3 ... 3 A, for example, can be used in combination with a 3UF1 8 interposing/current transformer.

Current/voltage measuring modules (voltage range)

Current/voltage measuring modules have the same functions as the current measuring modules. However, they can only be used in combination with basic unit 2. They offer the same current ranges for the rated motor current. Mounting on standard mounting rails, on mounting plates or directly on the contactor is also the same as with the current measuring modules. They can also measure voltages up to 690 V in the main circuit, which is necessary for calculating or monitoring power-related measured variables. Current/voltage measuring modules have additional removable terminals, to which the voltages of all three phases of the main circuit are connected (3-pole). An additional 3-core cable can be used, for example, to directly connect the main circuit from the busbar terminals of the current/voltage measuring modules to the voltage measuring terminals.

Note:
Current/voltage measuring modules can only be mounted separately from the associated basic unit 2. A current/voltage measuring module can only be used with a basic unit 2, product version E02 and later (from April 2005).

Width					
45 mm	55 mm	120 mm	145 mm		
					Current measuring modules
					Current/voltage measuring modules
Set current					
0.3 ... 3 A; 2.4 ... 25 A	10 ... 100 A	20 ... 200 A	63 ... 630 A		To measure and monitor motor currents up to 820 A, matching 3UF18 interposing current transformers are available for the current measuring modules and current/voltage measuring modules.
Straight-through transformers			Busbar connection		

Sizes and set current of the current measuring modules and the current/voltage measuring modules

SIMOCODE 3UF Motor Management and Control Devices

SIMOCODE pro 3UF7 motor management and control devices

Operator panel

The operator panel is used to control the motor feeder and can replace all conventional pushbuttons and indicator lights to save space. This means that SIMOCODE pro or the feeder can be operated directly at the control cabinet and that the system interface is connected externally for easier parameterization or diagnostics using a PC/PG, for example.

The operator panel is connected to the basic unit over a connection cable from its rear system interface and is supplied electrically from the basic unit.

The operator panel has 5 freely assignable buttons and a total of 10 LEDs, of which 7 LEDs can be used as required and assigned to any status signal.

A PC/PG can be connected to the front system interface over the PC cable.

The operator panel is mounted in the control cabinet door or the front plate of, for example, a withdrawable unit and satisfies IP54 degree of protection with the system interface covered.

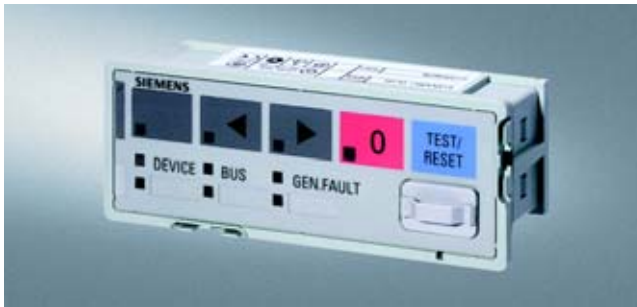

Operator panel for SIMOCODE pro

- 10 LEDs
- Labeling strips
- Test/reset button
- 4 control keys
- 2 system interfaces on the front with interface covers

Expansion modules for additional I/Os and functions

With basic unit 2 (SIMOCODE pro V), it is possible to expand the number and type of inputs and outputs in order to implement additional functions, for example. Each expansion module has two system interfaces on the front. Through the one system interface the expansion module is connected to the system interface of basic unit 2 using a connection cable, for example; through the second system interface, further expansion modules or the operator panel can be connected. The power supply for the expansion modules is provided by the connection cable through basic unit 2.

All expansion modules are suitable for rail mounting or can be directly fixed to a mounting plate using additional plug-in lugs. Basic unit 2 can be extended on the whole with up to 5 expansion modules.

Expansion with additional binary I/Os through digital modules

Up to two digital modules can be used to add additional binary inputs and relay outputs to basic unit 2. The input circuits of the digital modules are supplied from an external power supply. The following variants are available:

- 4 inputs, supplied externally with **24 V DC** and 2 **monostable** relay outputs
- 4 inputs, supplied externally with **110 ... 240 V AC/DC** and 2 **monostable** relay outputs
- 4 inputs, supplied externally with **24 V DC** and 2 **bistable** relay outputs
- 4 inputs, supplied externally with **110 ... 240 V AC/DC** and 2 **bistable** relay outputs

Up to two digital modules can be connected to one basic unit 2. All variants can be combined with each other.



3UF7 300-1AB00-0 (left) and 3UF7 300-1AU00-0 (right) digital modules

4 binary inputs, externally supplied with

- 24 V DC or
- 110 ... 240 V AC/DC

2 relay outputs,

- monostable or
- bistable (the switching status of the relay outputs is also maintained following failure of the supply voltage on basic unit 2)

1 Ready LED

2 system interfaces for connection

- to basic unit 2
- of expansion modules
- of a current measuring module or current/voltage measuring module
- of an operator panel

Note:

For the implementation of some motor control functions, in addition to the relay outputs on basic unit 2, at least one further digital module is required.

Expansion with a ground fault measuring module with an external summation current transformer

Instead of ground fault monitoring using the current measuring modules or current/voltage measuring modules, it may be necessary, especially in high-impedance grounded networks, to implement ground fault monitoring for smaller ground fault currents using a summation current transformer. A ground fault module can be used to add an additional input to basic unit 2 for connection of a summation current transformer (3UL2 20.-A).

Maximum one ground fault module can be connected to one basic unit 2.

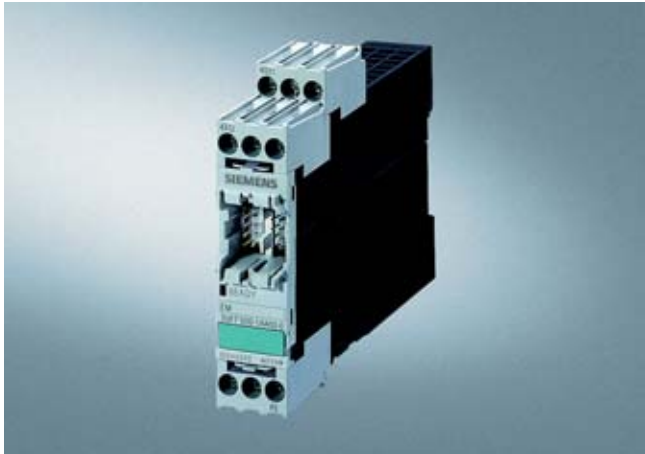

3UF7 500-1AA00-0 ground fault module

1 input for connecting a summation current transformer (3UL2 20.-A)

1 Ready LED

2 system interfaces for connection

- To basic unit 2
- Of expansion modules
- Of a current measuring module or current/voltage measuring module
- Of an operator panel

Note:

A ground fault module can only be used with a basic unit 2, product version E02 and later (from April 2005).

Expansion of analog temperature monitoring with a temperature module

Independently of the thermistor motor protection of the basic units, up to 3 analog temperature sensors can be evaluated using a temperature module.

The temperatures measured here can be completely integrated in the process, monitored and supplied to a higher-level automation system. The temperature module can be used, for example, for analog monitoring of the temperature of the motor windings or bearings or for monitoring the coolant or gear oil temperature. Various sensor types are supported (resistance sensors) for use in solid, liquid or gaseous media:

- PT100/PT1000
- KTY83/KTY84
- NTC

Maximum one temperature module can be connected to one basic unit 2. The same sensor type must be used in all sensor measuring circuits.



3UF7 700-1AA00-0 temperature module

3 inputs for connecting up to 3 resistance sensors in 2-wire or 3-wire circuits

1 Ready LED

2 system interfaces for connection

- To basic unit 2
- Of expansion modules
- Of a current measuring module or current/voltage measuring module
- Of an operator panel

Note:

A temperature module can only be used with a basic unit 2, product version E02 and later (from April 2005).



SIMOCODE pro 3UF7 motor management and control devices

Expansion with additional inputs/outputs by means of an analog module

Basic unit 2 can be optionally expanded with analog inputs and outputs (0/4 ... 20 mA) by means of the analog module. It is then possible to measure and monitor any process variable that can be mapped on a 0/4 ... 20 mA signal. Typical applications are, for example, level monitoring for the implementation of dry running protection for pumps or monitoring the degree of pollution of a filter using a differential pressure transducer. In this case the automation system has free access to the measured process variables. The analog output can be used, for example, to visualize process variables on a pointer instrument. The automation system also has free access to the output.

Maximum one analog module can be connected to one basic unit 2. Both inputs are set to a measuring range of either 0 ... 20 mA or 4 ... 20 mA.



3UF7 400-1AA00-0 analog module

Inputs:

- 2 inputs for measuring 0/4 ... 20 mA signals

Outputs:

- 1 output to output a 0/4 ... 20 mA signal

1 Ready LED

2 system interfaces for connection

- To basic unit 2
- Of expansion modules
- Of a current measuring module or current/voltage measuring module
- Of an operator panel

Note:

An analog module can only be used with a basic unit 2, product version E02 and later (from April 2005).

Safe isolation

All circuits in SIMOCODE pro are safely isolated from each other in according to IEC 60947-1. That is, they are designed with double creepage and air distances. In the event of a fault, therefore, no parasitic voltages can be formed in neighboring circuits. The instructions of test report No. 2668 must be complied with.

EEx e and EEx d types of protection

The overload protection and the thermistor motor protection of the SIMOCODE pro system comply with the requirements for overload protection of explosion-protected motors to the degree of protection:

- EEx d "flameproof enclosure" e.g. according to EN 50018 or EN 60079-1
- EEx e "increased safety" e.g. according to EN 50019 or EN 60079-7

When using SIMOCODE pro devices with a 24 V DC control voltage, electrical isolation must be ensured using a battery or a safety transformer according to EN 61558-2-6.

EC type test certificate: BVS 04 ATEX F 003
Test log: BVS PP 05.2029 EG.

Function

Multifunctional, solid-state full motor protection

Current-dependent electronic overload protection with adjustable tripping characteristics (Classes 5, 10, 15, 20, 25, 30, 35 and 40)

- SIMOCODE pro protects three-phase or AC motors according to IEC 60947-4-1 requirements. The trip class can be adjusted in eight steps from Class 5 to Class 40. In this way, the break time can be adapted very accurately to the load torque which allows the motor to be utilized more effectively. In addition, the time until the overload tripping operation is performed is calculated and can be made available to the I&C system. After an overload tripping operation, the remaining cooling time can be displayed (characteristic curves for 2-pole and 3-pole loading in SIMOCODE pro System Manual).

Phase failure/unbalance protection

- The level of the phase unbalance can be monitored and transmitted to the I&C system. If a specified limit value is violated, a defined and delayable response can be initiated. If the phase unbalance is larger than 50 %, the tripping time is also automatically reduced according to the overload characteristic since the heat generation of the motors increases in unbalanced conditions.

Stall protection

- If the motor current rises above an adjustable blocking threshold (current threshold), a defined and delayable response can be configured for SIMOCODE pro. In this case, for example, the motor can be shut down independent of the overload protection. The blocking protection is only enabled after the configured class time has elapsed and avoids unnecessarily high thermal and mechanical loads as well as wear of the motor.

Thermistor motor protection

- This protection function is based on direct temperature measurements by means of temperature sensors in the stator windings or in the enclosure of the motor. These protective functions should be used, in particular, in motors with high operating frequencies, heavy-duty starting, intermittent and/or braking operation, but also in the case of speeds lower than the rated speed. SIMOCODE pro supports connection and evaluation of several PTC sensors connected in series on the basic unit. In addition, the sensor measuring circuit can be monitored for short-circuits and wire breakages. If the temperature of the motor increases beyond a defined limit or if there is a fault in the sensor measuring circuit, a defined response can be configured.

Ground-fault monitoring (internally) with a current measuring module or current/voltage measuring module

- SIMOCODE pro acquires and monitors all three phase currents. With vector addition of the phase currents, the motor feeder can be monitored for possible fault currents or ground faults with the help of internal calculations. Internal earth fault monitoring is only available for motors with three-phase connections in directly grounded networks or in networks grounded with low impedance. The response of SIMOCODE pro when a ground fault is detected can be parameterized and delayed as required.

Ground-fault monitoring (external) with summation current transformer¹⁾²⁾

- External ground-fault monitoring is normally implemented for networks that are grounded with high impedance. Using an additional summation current transformer (3UL2 20.-A), even extremely low ground-fault currents can be measured. The response of SIMOCODE pro when a ground fault is detected can be parameterized and delayed as required. Fault current measurement is performed for each summation current transformer for the following fault currents: 0.3/0.5/1 A

Monitoring of adjustable limit values for the motor current

- Current limit value monitoring is used for process monitoring independent of overload protection. Violation of a current limit value below the overload threshold can be an indication for a dirty filter in a pump or for an increasingly sluggish motor bearing, for example. Violation of the lower current limit value can be a first indication of a worn drive belt. SIMOCODE pro supports two-step monitoring of the motor current for freely selectable upper and lower current limit values. The response of SIMOCODE pro can be freely configured and delayed if it reaches an alarm or tripping threshold.

Voltage monitoring³⁾

- By measuring the voltage directly at the circuit-breaker or at the fuses in the main circuit, even when the motor is deactivated, SIMOCODE pro can also obtain information about the reclosing capability of the feeder and signal it if required.
- SIMOCODE pro supports two-stage undervoltage monitoring for freely selectable limit values. The response of SIMOCODE pro can be freely configured and delayed if it reaches an alarm or tripping threshold.

Monitoring the active power³⁾

- The active power characteristic of a motor provides an accurate statement of the actual loading over the complete range. Excessive loading will cause increased wear in the motor and can result in early failure. Insufficient active power can be an indication of, for example, motor idling.
- SIMOCODE pro supports two-step monitoring of the active power for freely selectable upper and lower current limit values. The response of SIMOCODE pro can be freely configured and delayed if it reaches an alarm or tripping threshold.

Monitoring the power factor³⁾

- Especially in the low-end performance range of a motor, the power factor varies more than the motor current or active power. Monitoring of the power factor is therefore particularly useful for distinguishing between motor idling and fault events such as a tear in a drive belt or a crack in a drive shaft.
- SIMOCODE pro supports two-stage monitoring of power factor undershoot for freely selectable limit values. The response of SIMOCODE pro can be freely configured and delayed if it reaches an alarm or tripping threshold.

Temperature monitoring¹⁾⁴⁾

- The temperature can be monitored, for example, in the motor windings or at the bearings through up to three resistance sensors connected to the temperature module.
- SIMOCODE pro supports two-stage monitoring of overheating for freely selectable limit values. The response of SIMOCODE pro can be freely configured and delayed if it reaches an alarm or tripping threshold. Temperature monitoring is always performed with reference to the highest temperature of all sensor measuring circuits used.

1) Using basic unit 2.

2) An additional ground-fault module with a 3UL22 summation current transformer is required.

3) Using basic unit 2 with current/voltage measuring module.

4) An additional temperature module is required.

SIMOCODE pro 3UF7 motor management and control devices

Monitoring additional process variables over analog inputs (0/4 ... 20 mA)¹⁾²⁾

- The analog module enables SIMOCODE pro to measure additional process variables and monitor them. A pump can, for example, be protected against dry running in this manner with level monitoring or the degree of pollution of a filter can be measured using a differential pressure transducer. When a specified level is undershot, the pump can be deactivated and when a specified differential pressure is overshot, the filter can be cleaned.
- SIMOCODE pro supports two-step monitoring of the corresponding process variable for freely selectable upper and lower current limit values. The response of SIMOCODE pro can be freely configured and delayed if it reaches an alarm or tripping threshold.

Phase sequence detection³⁾

- By detecting the phase sequence, SIMOCODE pro is able to make a statement about the direction of rotation of a motor. If the direction is incorrect, this can be reported or it can result in immediate shutdown of the affected motor.

Monitoring of operating hours, downtime and number of starts

- In order to prevent plant downtime caused by motor failure due to excessive motor operating times (wear) or excessive motor downtimes, SIMOCODE pro can monitor the operating hours and downtime of a motor. When an adjustable limit value is violated, a message or alarm can be generated which can indicate that the corresponding motor must be serviced or replaced. After the motor has been replaced, the operating hours and downtimes can be reset, for example.
- To avoid excessive thermal loads and early wear of the motor, it is possible to limit the number of motor startups for a specifiable period. Alarms can indicate that only a small number of possible starts remain.

Flexible motor control implemented with software

Many typical motor control functions have been predefined in SIMOCODE pro and are available for use:

- Direct-on-line and reversing starters
- Wye-delta starters (also with direction reversal)¹⁾
- Two speeds, motors with separate windings (pole-changing switch); also with direction reversal¹⁾
- Two speeds, motors with separate Dahlander windings (also with direction reversal)¹⁾
- Slide control¹⁾
- Solenoid valve actuation¹⁾
- Actuation of a circuit-breaker (MCCB)
- Actuation of a 3RW soft starter also with direction reversal¹⁾

These control programs already include all the software interlocks and logic operations required for operation of the required motor functions.

It is also monitored whether the current checkback of the motor feeder corresponds with the control command. If not, SIMOCODE pro opens the motor contactor and generates an alarm indication.

Depending on the application, motor control can be switched over or carried out simultaneously from several control stations, e.g.:

- From the I&C system through PROFIBUS DP
- From a PC/PG through PROFIBUS DP
- From the control cabinet door through the operator panel
- From a PC/PG on the system interface through SIMOCODE pro
- From a local control station on the motor. In this case, the buttons, switches and indicator lights are connected to the inputs and outputs of SIMOCODE pro.

Regardless of whether a control command is sent to SIMOCODE pro via PROFIBUS DP using the operator module or via the buttons connected to the binary SIMOCODE pro inputs, SIMOCODE pro can execute these control commands simultaneously or in accordance with the enabled commands defined during configuration.

These predefined control functions can also be flexibly adapted to each customized configuration of a motor feeder by means of freely configurable logic modules (truth tables, counters, timers, edge evaluation etc.).

In addition, special standard functions are stored in SIMOCODE pro which can also be used to extend the protection and control functions, e.g.:

- Power failure monitoring¹⁾ for automatic, time-staggered restart of motors following a network failure e.g. with the help of a separate voltage relay (voltage controller).
- Fault signaling modules for external faults with or without manual or automatic acknowledgement for generating internal messages or for tripping SIMOCODE pro in response to freely definable events (e.g. overspeed monitor has been activated). Designations/names can also be assigned to the external faults which are stored in the device and which are therefore also available to the I&C system.
- Emergency start function and reset of the thermal memory of SIMOCODE pro after tripping, i.e. immediate restart is possible (important, for example, for pumps used to extinguish fires).
- Test function for the load feeder circuit when the main control switch is open to test the control circuit while the main circuit is de-energized.

Detailed operational, service and diagnostics data

SIMOCODE pro provides a variety of operating, service and diagnostic data, such as:

Operating data

- The switching state of the motor (On, Off, clockwise, counter-clockwise, fast, slow) is derived from the current flow in the main circuit, so checkbacks are not required through auxiliary contacts from circuit-breakers and contactors
- Current in phase 1, 2, 3 and maximum current in % of the set current
- Voltage in phases 1, 2, 3 in V³⁾
- Active power in W³⁾
- Apparent power in VA³⁾
- Power factor in %³⁾
- Phase unbalance in %
- Phase sequence³⁾
- Temperature in sensor circuits 1, 2, 3 and maximum temperature in °C¹⁾⁴⁾
- Current values of the analog signals¹⁾²⁾
- Time until tripping in sec.
- Temperature rise for motor model in %
- Remaining cooling time of the motor in sec. etc.

Service data

- Motor operating hours (can be reset)
- Motor stop times (can be reset)
- Number of motor starts (can be reset)
- Number of remaining permissible motor starts
- Number of overload trips (can be reset)
- Internal comments, stored in the device for each feeder, e.g. notes for maintenance events etc.

1) Using basic unit 2.

2) An additional analog module is required.

3) Using basic unit 2 with current/voltage measuring module.

4) An additional temperature module is required.

Diagnostic data

- Numerous detailed early warning and fault messages (can also be used for further processing in the device or I&C system)
- Internal device fault logging with time stamp
- Value of the previous tripping current
- Checkback error (e.g. no current flow in the main circuit following ON control command) etc.

Integration

General

In addition to device function and hardware design, a great deal of emphasis is placed on the ease of communication-capable controlgear on the user-friendliness of the configuration software and the ability of the system to be integrated easily into various different system configurations and process automation systems. For this reason, the SIMOCODE pro system provides suitable software tools for consistent, time-saving parameterization, configuration and diagnostics:

- SIMOCODE ES for totally integrated startup and service
- OM SIMOCODE pro object manager for total integration into SIMATIC S7
- PCS 7 function block library SIMOCODE pro for total integration into PCS 7

SIMOCODE ES

The parameterization software for SIMOCODE pro can be run on a PC/PG under Windows 2000 or Windows XP. It is available in two functionally graded versions:

- **SIMOCODE ES Smart**, for direct connection to SIMOCODE pro via the system interface on the device (point-to-point)
- **SIMOCODE ES Professional**, for connection to one or several devices over PROFIBUS DP or point-to-point through the system interface

With SIMOCODE ES, the SIMOCODE motor management system provides a user-friendly and clear-cut user interface with which to configure, operate, monitor and test SIMOCODE pro in the field or from a central location. By displaying all operating, service and diagnostics data, SIMOCODE ES supplies important information on whether maintenance work is required or, in the event of a fault, helps to prevent faults or to localize and rectify them once they have occurred.

Unnecessary plant downtimes can be prevented by changing parameters online (even during operation). The flexible printing function integrated into SIMOCODE ES allows comprehensive documentation of all parameters or partial documentation of selected or changed parameters.

- **SIMOCODE ES Graphic** is an optional software package for SIMOCODE ES Smart or SIMOCODE ES Professional. It expands the user interface with a graphical editor and supports extremely user-friendly parameterization with Drag & Drop. Inputs and outputs of function blocks can be graphically linked and parameters can be set. The configured functions can be described in greater detail using comments and the device parameterization can be documented graphically – this speeds up start-up and simplifies the plant documentation.

Note:

Installation of SIMOCODE ES Graphic requires at least one installed version of SIMOCODE ES Smart 2004+SP1 or SIMOCODE ES Professional+SP1 (from April 2005) on the PC/PG.

Autonomous operation

An essential feature of SIMOCODE pro is independent execution of all protection and control functions even if communication with the I&C system breaks down. If the bus or automation system fails, the full functionality of the feeder is ensured or a pre-defined response can be initiated, e.g. the feeder can be shut down in a controlled manner or certain configured control mechanisms can be performed (e.g. the direction of rotation can be reversed).

OM SIMOCODE pro object manager (as part of SIMOCODE ES Professional)

The **OM SIMOCODE pro** object manager is a standard component of **SIMOCODE ES Professional**. In contrast to a conventional GSD file, it enables SIMOCODE ES to be integrated into STEP 7 for convenient device parameterization. By installing SIMOCODE ES Professional and OM SIMOCODE pro on a PC/PG, which is used to configure the hardware of the SIMATIC S7, SIMOCODE ES Professional can be called directly from the hardware configuration. This allows easy and consistent S7 configuration.

PCS 7 function block library for SIMOCODE pro

The SIMOCODE pro PCS 7 library can be used for simple and easy integration of SIMOCODE pro into the SIMATIC PCS 7 V6 process control system. The SIMOCODE pro PCS 7 function block library contains the diagnostic and driver blocks corresponding with the diagnostic and driver concept of SIMATIC PCS 7 as well as the elements (symbols and faceplate) required for operator control and process monitoring. The application is integrated by graphic interconnection using the CFC Editor.

The technological and signal processing functions of the SIMOCODE pro PCS 7 function block library are based on the SIMATIC PCS 7 standard libraries (driver blocks, technological blocks) and are optimally tailored to SIMOCODE pro. Users who previously configured motor feeder circuits using conventional technology by means of signal blocks and motor or valve blocks, can now easily switch to the SIMOCODE pro PCS 7 function block library.

The SIMOCODE pro PCS 7 function block library supplied on CD-ROM allows the user to run the required engineering software on the engineering station (single license) including the runtime software for executing the AS blocks in an automation system (single license). If the AS blocks are to be used in additional automation systems, the corresponding number of runtime licenses are required which are supplied without a data carrier.

System manual for SIMOCODE pro

The SIMOCODE pro system manual describes the motor management system and its functions in detail. It contains information about configuration and commissioning as well as servicing and maintenance. A typical example of a reversing starter application is used to teach the user quickly and practically how to use the system. In addition to help on how to identify and rectify faults in the event of a malfunction, the manual also contains special information for servicing and maintenance.

Furthermore, the manual contains schematics, dimensional drawings and technical specifications of the system components as configuring aids.

SIMOCODE 3UF Motor Management and Control Devices

SIMOCODE pro 3UF7 motor management and control devices

Technical specifications

General data applicable to the basic units, current measuring modules, current/voltage measuring modules, expansion modules and operator panel		
Permissible ambient temperature		
• During operation	°C	-25 ... +60
• Storage and transport	°C	-40 ... +80
Installation altitude above sea level	m	≤ 2000
• Permissible ambient temperature max. +50 °C (no safe isolation)	m	≤ 3000
• Permissible ambient temperature max. +40 °C (no safe isolation)	m	≤ 4000
Degree of protection (acc. to IEC 60529)		
• All components (except for current measuring modules or current/voltage measuring modules for busbar connection, operator panel and door adapter)		IP20
• Current measuring modules or current/voltage measuring module with busbar connection		IP00
• Operator panel (front) and door adapter (front) with cover		IP54
Shock resistance (sine pulse)	g/ms	15/11
Mounting position		Any
Frequency	Hz	50/60 ±5 %
Immunity to electromagnetic interferences (acc. to IEC 60947-1)		Corresponds to degree of severity 3
• Line-induced interference, burst acc. to IEC 61000-4-4	kV	2 (power ports)
	kV	1 (signal port)
	V	10
• Conducted interference, high frequency acc. to IEC 61000-4-6	kV	2 (line to ground)
• Line-induced interference, surge acc. to IEC 61000-4-5	kV	1 (line to line)
	kV	8 (air discharge)
• Electrostatic discharge, ESD acc. to IEC 61000-4-2	kV	6 (contact discharge)
	kV	10
• Field-related interference acc. to IEC 61000-4-3	V/m	
Immunity to electromagnetic interferences (acc. to IEC 60947-1)		EN 55011 / EN 55022 (CISPR 11 / CISPR 22)
• Line-conducted and radiated interference emission		(corresponds to degree of severity A)
Safe isolation (acc. to IEC 60947-1)		All circuits in SIMOCODE pro are safely isolated from each other acc. to IEC 60947-1, they are designed with doubled creepage paths and clearances In this context, compliance with the instructions in the test report "Safe Isolation" No. 2668 is required.
Basic units		
Mounting		Snap-on mounting onto 35 mm standard mounting rail or screw fixing with additional push-in lugs
Displays		Green: "Ready" Red: "Function test not OK; device is disabled" Off: "No control supply voltage" Continuous light: "Communication with PLC/PCS" Flashing: "Baud rate recognized/communicating with PC/PG" Continuous light/flashing: "Feeder fault", e.g. Overload tripping
• Red/green "DEVICE" LED		
• Green "BUS" LED		
• Red "GEN. FAULT" LED		
Test/Reset buttons		• Resets the device after tripping • Function test • Operation of a memory module or addressing plug
System interfaces		Connection of an operator panel or expansion modules; the memory module, addressing plug or a PC cable can also be connected to the system interface for parameterizing
• Front		Connection of a current measuring module or current/voltage measuring module
• Bottom		
PROFIBUS DP interface		Connection of the PROFIBUS DP cable over terminals or over a 9-pin sub D female connector

Basic units

Control circuit

Rated control supply voltage U_s (acc. to EN 61131-2)		110 ... 240 V AC/DC; 50/60 Hz	24 V DC								
Operating range		0.85 ... 1.1 × U_s	0.8 ... 1.2 × U_s								
Power input • Basic unit 1 (3UF7 000) • Basic unit 2 (3UF7 010) incl. two expansion modules connected to basic unit 2		7 VA 10 VA	5 W 7 W								
Rated insulation voltage U_i	V	300 (at pollution degree 3)									
Rated impulse withstand voltage U_{imp}	kV	4									
Relay outputs • Number • Auxiliary contacts of the 3 relay outputs • Specified short-circuit protection for auxiliary contacts (relay outputs) • Rated uninterrupted current • Rated short-circuit capacity		<p>3 monostable relay outputs Floating NO contact (NC contact response can be parameterized with internal signal conditioning), 2 relay outputs are jointly and 1 relay output is separately connected to a common potential; they can be freely assigned to the control functions (e.g. for line, wye and delta contactors and for signaling the operating status)</p> <ul style="list-style-type: none"> • Fuse links, operational class gL/gA 6 A, quick 10 A (IEC 60947-5-1) • Miniature circuit-breaker 1.6 A, C characteristic (IEC 60947-5-1) • Miniature circuit-breaker 6 A, C characteristic ($I_k < 500$ A) <p>6</p> <table border="0"> <tr> <td>AC-15</td> <td>6 A/24 V AC</td> <td>6 A/120 V AC</td> <td>3 A/230 V AC</td> </tr> <tr> <td>DC-13</td> <td>2 A/24 V DC</td> <td>0.55 A/60 V DC</td> <td>0.25 A/125 V DC</td> </tr> </table>		AC-15	6 A/24 V AC	6 A/120 V AC	3 A/230 V AC	DC-13	2 A/24 V DC	0.55 A/60 V DC	0.25 A/125 V DC
AC-15	6 A/24 V AC	6 A/120 V AC	3 A/230 V AC								
DC-13	2 A/24 V DC	0.55 A/60 V DC	0.25 A/125 V DC								
Inputs (binary)		4 inputs supplied internally by the device electronics with 24 V DC and connected to a common potential for acquiring process signals (e.g. local control station, key switch, limit switch, ...), freely assignable to control functions									
Thermistor motor protection (binary PTC) • Summation cold resistance • Operating value • Return value	kΩ	<p>≤ 1.5 3.4 ... 3.8 1.5 ... 1.65</p>									
Conductor cross-sections • Tightening torque • Solid • Finely stranded with end sleeve • AWG cable (solid) • AWG cable (finely stranded)	Nm mm ² mm ² AWG AWG	<p>0.8 ... 1.2 1 × (0.5 ... 4.0); 2 × (0.5 ... 2.5) 1 × (0.5 ... 2.5); 2 × (0.5 ... 1.5) 1 × AWG 20 to 12/2 × AWG 20 to 14 1 × AWG 20 to 14/2 × AWG 20 to 16</p>									

Current measuring modules or current/voltage measuring modules

Mounting • Set current $I_e = 0.3 ... 3$ A; 2.4 ... 25 A; 10 ... 100 A (3UF7 1.0, 3UF7 1.1, 3UF7 1.2) • Set current $I_e = 20 ... 200$ A (3UF7 103, 3UF7 113) • Set current $I_e = 63 ... 630$ A (3UF7 104, 3UF7 114)		<p>Snap-on mounting onto 35 mm standard mounting rail or screw fixing with additional push-in lugs Snap-on mounting onto 35 mm standard mounting rail, screwing onto mounting plate or direct fixing on contactor Screw fixing onto mounting plate or direct fixing on contactor</p>	
System interfaces		for connection to a basic unit	

Main circuit

		3UF7 1.0	3UF7 1.1	3UF7 1.2	3UF7 1.3	3UF7 1.4
Set current I_e	A	0.3 ... 3	2.4 ... 25	10 ... 100	20 ... 200	63 ... 630
Rated insulation voltage U_i (with pollution degree 3)	V	690			1000	
Rated impulse withstand voltage U_{imp}	kV	6			8	
Rated frequency	Hz	50/60				
Type of current		Three-phase current				
Short-circuit		Additional short-circuit protection is required in main circuit ¹⁾				
Accuracy of current measurement (in the range 1 x minimum set current I_u to 8 x max. set current I_o)	%	±3				
Typical voltage measuring ranges • Phase-to-phase voltage/line-to-line voltage (e.g. U_{L1L2}) • Phase voltage (e.g. U_{L1})	V V	<p>110 ... 690 65 ... 400</p>				
Accuracy • Of voltage measurement (phase voltage U_L in the range 230 ... 400 V) • Of power factor measurement • Of apparent power measurement	% % %	<p>±3 (typical) ±5 (typical) ±5 (typical)</p>				
Notes on voltage measurement • Grounded network • Rated control supply voltage U_s		suitable for three-phase supply with grounded neutral point grounded mass or neutral conductor is required				



SIMOCODE pro 3UF7 motor management and control devices

Current measuring modules or current/voltage measuring modules

Connection for main circuit

Feed-through opening (diameter)

- Set current $I_b = 0.3 \dots 3 \text{ A}$; $2.4 \dots 25 \text{ A}$
- Set current $I_b = 10 \dots 100 \text{ A}$
- Set current $I_b = 20 \dots 200 \text{ A}$

Busbar connection¹⁾

- Set current I_b
- Terminal screw
- Tightening torque
- Solid with cable lug
- Stranded with cable lug
- AWG cable

Conductor cross-sections for voltage measurement

- Tightening torque
- Solid
- Finely stranded with end sleeve
- AWG cable (solid)
- AWG cable (finely stranded)

mm	7.5	
mm	14.0	
mm	25.0	
A	20 ... 200	63 ... 630
Nm	M8 x 25	M10 x 30
mm ²	10 ... 14	14 ... 24
mm ²	16 ... 95 ²⁾	50 ... 240 ³⁾
mm ²	25 ... 120 ²⁾	70 ... 240 ³⁾
AWG	6 ... 3/0 kcmil	1/0 ... 500 kcmil
Nm	0.8 ... 1.2	
mm ²	1 x (0.5 ... 4.0); 2 x (0.5 ... 2.5)	
mm ²	1 x (0.5 ... 2.5); 2 x (0.5 ... 1.5)	
AWG	1 x AWG 20 to 12/2 x AWG 20 to 14	
AWG	1 x AWG 20 to 14/2 x AWG 20 to 16	

Digital modules

Mounting

Snap-on mounting onto 35 mm standard mounting rail or screw fixing with additional push-in lugs

Displays

- Green LED "READY"

Continuous light: "Ready"
Flashing: "No connection to the PC"

System interfaces

for connecting to a basic unit, another expansion module, a current measuring module or current/voltage measuring module or to the operator panel

Control circuit

Rated insulation voltage U_i

V 300 (at pollution degree 3)

Rated impulse withstand voltage U_{imp}

kV 4

Relay outputs

- Number
- Auxiliary contacts of the 2 relay outputs

2 monostable or bistable relay outputs (depending on the variant)
Floating NO contact (NC contact response can be parameterized with internal signal conditioning), all relay outputs are jointly connected to a common potential, they can be freely assigned to the control functions (e.g. for line, wye and delta contactors and for signaling the operating status)

- Fuse links, operational class gL/gG 6 A, quick 10 A (IEC 60947-5-1)
- Miniature circuit-breaker 1.6 A, C characteristic (IEC 60947-5-1)
- Miniature circuit-breaker 6 A, C characteristic ($I_k < 500 \text{ A}$)

- Specified short-circuit protection for auxiliary contacts (relay outputs)

- Rated uninterrupted current
- Rated short-circuit capacity

A
6
AC-15 6 A/24 V AC 6 A/120 V AC 3 A/230 V AC
DC-13 2 A/24 V DC 0.55 A/60 V DC 0.25 A/125 V DC

Inputs (binary)

4 externally supplied floating inputs, 24 V DC or 110 to 240 V AC/DC depending on the variant; inputs jointly connected to common potential for sensing process signals (e.g.: local control station, key switch, limit switch ...), freely assignable to the control functions

Conductor cross-sections

- Tightening torque
- Solid
- Finely stranded with end sleeve
- AWG cable (solid)
- AWG cable (finely stranded)

Nm 0.8 ... 1.2
mm² 1 x (0.5 ... 4.0); 2 x (0.5 ... 2.5)
mm² 1 x (0.5 ... 2.5); 2 x (0.5 ... 1.5)
AWG 1 x AWG 20 to 12/2 x AWG 20 to 14
AWG 1 x AWG 20 to 14/2 x AWG 20 to 16

Ground fault modules

Mounting

Snap-on mounting onto 35 mm standard mounting rail or screw fixing with additional push-in lugs

Displays

- Green LED "READY"

Continuous light: "Ready"
Flashing: "No connection to the PC"

System interfaces

for connecting to a basic unit, another expansion module, a current measuring module or current/voltage measuring module or to the operator panel

Control circuit

Connectable 3UL22 summation current transformer with rated fault currents I_N

A 0.3/0.5/1

- $I_{\text{Ground fault}} \leq 50 \% I_N$
- $I_{\text{Ground fault}} \geq 100 \% I_N$

No tripping
Tripping

Response delay

ms 300 ... 500, additionally delayable

Conductor cross-sections

- Tightening torque
- Solid
- Finely stranded with end sleeve
- AWG cable (solid)
- AWG cable (finely stranded)

Nm 0.8 ... 1.2
mm² 1 x (0.5 ... 4.0); 2 x (0.5 ... 2.5)
mm² 1 x (0.5 ... 2.5); 2 x (0.5 ... 1.5)
AWG 1 x AWG 20 to 12/2 x AWG 20 to 14
AWG 1 x AWG 20 to 14/2 x AWG 20 to 16

1) Screw connection is possible using a suitable 3RT19 ... box terminal.

2) When connecting cable lugs acc. to DIN 46235, use the 3RT19 56-4EA1 terminal cover for conductor cross-sections from 95 mm² to ensure phase spacing.

3) When connecting cable lugs acc. to DIN 46234 for conductor cross-sections from 240 mm² as well as DIN 46235 for conductor cross-sections from 185 mm², use the 3RT19 66-4EA1 terminal cover to ensure phase spacing.

Temperature modules				
Mounting	Snap-on mounting onto 35 mm standard mounting rail or screw fixing with additional push-in lugs			
Displays • Green LED "READY"	Continuous light: "Ready" Flashing: "No connection to the PC"			
System interfaces	for connecting to a basic unit, another expansion module, a current measuring module or current/voltage measuring module or to the operator panel			
Sensor circuits				
Typical sensor circuits • PT100 • PT1000/KTY83/KTY84/NTC	mA 1 (typical) 0.2 (typical)			
Wire-break/short-circuit detection • For sensor type • Open-circuit • Short-circuit • Measuring range	PT100/PT1000 • • °C -50 ... +500	KTY83-110 • • -50 ... +175	KTY84 • • -40 ... +300	NTC -- • +80 ... +160
Measuring accuracy at 20 °C ambient temperature (T20)	K	< ±2		
Deviation due to ambient temperature (in % of measuring range)	%	0.05 per K deviation from T20		
Conductor cross-sections • Tightening torque • Solid • Finely stranded with end sleeve • AWG cable (solid) • AWG cable (finely stranded)	Nm mm ² mm ² AWG AWG	0.8 ... 1.2 1 × (0.5 ... 4.0); 2 × (0.5 ... 2.5) 1 × (0.5 ... 2.5); 2 × (0.5 ... 1.5) 1 × AWG 20 to 12/2 × AWG 20 to 14 1 × AWG 20 to 14/2 × AWG 20 to 16		
Analog modules				
Mounting	Snap-on mounting onto 35 mm standard mounting rail or screw fixing with additional push-in lugs			
Displays • Green LED "READY"	Continuous light: "Ready" Flashing: "No connection to the PC"			
System interfaces	for connecting to a basic unit, another expansion module, a current measuring module or current/voltage measuring module or to the operator panel			
Control circuits				
Inputs • Channels • Parameterizable measuring ranges • Shielding • Max. input current (destruction limit) • Accuracy • Input resistance • Conversion time • Resolution • Open-circuit detection	mA mA % Ω ms bit	2 0/4 ... 20 up to 30 m shield recommended, from 30 m shield required 40 1 50 130 12 with measuring range 4 ... 20 mA		
Outputs • Channels • Parameterizable output range • Shielding • Max. voltage at output • Accuracy • Max. output load • Conversion time • Resolution • Short-circuit resistant	mA %	1 0/4 ... 20 up to 30 m shield recommended, from 30 m shield required 30 V DC 1 500 10 12 yes		
Connection type		2-wire connection		
Voltage isolation of inputs/outputs to the device electronics		no		
Conductor cross-sections • Tightening torque • Solid • Finely stranded with end sleeve • AWG cable (solid) • AWG cable (finely stranded)	Nm mm ² mm ² AWG AWG	0.8 ... 1.2 1 × (0.5 ... 4.0); 2 × (0.5 ... 2.5) 1 × (0.5 ... 2.5); 2 × (0.5 ... 1.5) 1 × AWG 20 to 12/2 × AWG 20 to 14 1 × AWG 20 to 14/2 × AWG 20 to 16		



SIMOCODE 3UF Motor Management and Control Devices

SIMOCODE pro 3UF7 motor management and control devices

Operator panels	
Mounting	Mounted in a control cabinet door or in a front panel, IP54 with system interface cover
Displays <ul style="list-style-type: none"> • Red/green "DEVICE" LED • Green "BUS" LED • Red "GEN. FAULT" LED • Green or yellow LEDs 	Green: "Ready" Green flashing: "No connection to the basic unit" Red: "Function test not OK; device is disabled" Off: "No control supply voltage" Continuous light: "Communication with PLC/PCS" Flashing: "Baud rate recognized/communicating with PC/PG" Continuous light/flash: "Feeder fault", e.g. Overload tripping for assigning to any status signals, as required
Keys <ul style="list-style-type: none"> • Test/Reset • Control keys 	<ul style="list-style-type: none"> • Resets the device after tripping • Function test • Operation of a memory module or addressing plug for controlling the motor feeder, user-assignable
System interfaces <ul style="list-style-type: none"> • Front • Rear 	for plugging in a memory module, an addressing plug or a PC cable for parameterization Connection to the basic unit or to an expansion module

SIMOCODE 3UF Motor Management and Control Devices

SIMOCODE pro 3UF7 motor management and control devices

Short-circuit protection with fuses for motor feeders for short-circuit currents up to 50 kA and 690 V for 3UF7

Current measuring modules or current/voltage measuring modules	Contactors Types	CLASS 5 and Class 10			CLASS 15			CLASS 20			CLASS 25			
		Rated operational current $I_n/AC-3$ in A at ... V												
		400	500	690	400	500	690	400	500	690	400	500	690	
Set current 0.3 ... 3.0 A														
3UF7 1 . 0-1AA00-0	3RT10 15	3.0	3.0	3.0	3.0	3.0	3.0	3.0	3.0	3.0	3.0	3.0	3.0	
	3RT10 16	3.0	3.0	3.0	3.0	3.0	3.0	3.0	3.0	3.0	3.0	3.0	3.0	
Set current 2.4 ... 25 A														
3UF7 1 . 1-1AA00-0	3RT10 15	7.0	5.0	4.0	7.0	5.0	4.0	7.0	5.0	4.0	7.0	5.0	4.0	
	3RT10 16	9.0	6.5	5.2	9.0	6.5	5.2	9.0	6.5	5.2	9.0	6.5	5.2	
	3RT10 17	12.0	9.0	6.3	11.0	9.0	6.3	10.0	9.0	6.3	9.5	9.0	6.3	
	3RT10 23	9.0	6.5	5.2	9.0	6.5	5.2	9.0	6.5	5.2	--	--	--	
	3RT10 24	12.0	12.0	9.0	12.0	12.0	9.0	12.0	12.0	9.0	12.0	12.0	9.0	
	3RT10 25	17.0	17.0	13.0	17.0	17.0	13.0	16.0	16.0	13.0	15.0	15.0	13.0	
	3RT10 26	25.0	18.0	13.0	18.0	18.0	13.0	16.0	16.0	13.0	15.0	15.0	13.0	
	3RT10 34	25.0	25.0	20.0	25.0	25.0	20.0	22.3	22.3	20.0	20.3	20.3	20.3	
	3RT10 35	25.0	25.0	24.0	25.0	25.0	24.0	25.0	25.0	24.0	25.0	25.0	24.0	
	Set current 10 ... 100 A													
	3UF7 1 . 2-1AA00-0	3RT10 34	32.0	32.0	20.0	25.5	25.5	20.0	22.3	22.3	20.0	20.3	20.3	20.0
3RT10 35		40.0	40.0	24.0	33.0	33.0	24.0	29.4	29.4	24.0	28.0	28.0	24.0	
3RT10 36		50.0	50.0	24.0	38.5	38.5	24.0	32.7	32.7	24.0	29.4	29.4	24.0	
3RT10 44		65.0	65.0	47.0	56.0	56.0	47.0	49.0	49.0	47.0	45.0	45.0	45.0	
3RT10 45		80.0	80.0	58.0	61.0	61.0	58.0	53.0	53.0	53.0	47.0	47.0	47.0	
3RT10 46		95.0	95.0	58.0	69.0	69.0	58.0	59.0	59.0	58.0	53.0	53.0	53.0	
3RT10 54		100.0	100.0	100.0	93.2	93.2	93.2	81.7	81.7	81.7	74.8	74.8	74.8	
3RT10 55		--	--	--	100.0	100.0	100.0	100.0	100.0	100.0	97.5	97.5	97.5	
Set current 20 ... 200 A														
3UF7 1 . 3-1 . A00-0	3RT10 54	115	115	115	93.2	93.2	93.2	81.7	81.7	81.7	74.8	74.8	74.8	
	3RT10 55	150	150	150	122	122	122	107	107	107	98	98	98	
	3RT10 56	185	185	170	150	150	150	131	131	131	120	120	120	
Set current 63 ... 630 A														
3UF7 1 . 4-1BA00-0	3RT10 64	225	225	225	182	182	182	160	160	160	146	146	146	
	3RT10 65	265	265	265	215	215	215	188	188	188	172	172	172	
	3RT10 66	300	300	280	243	243	243	213	213	213	195	195	195	
	3RT10 75	400	400	400	324	324	324	284	284	284	260	260	260	
	3RT10 76	500	500	450	405	405	405	355	355	355	325	325	325	
	3RT12 64	225	225	225	225	225	225	225	225	225	194	194	194	
	3RT12 65	265	265	265	265	265	265	265	265	265	228	228	228	
	3RT12 66	300	300	300	300	300	300	300	300	300	258	258	258	
	3RT12 75	400	400	400	400	400	400	400	400	400	344	344	344	
	3RT12 76	500	500	500	500	500	500	500	500	500	430	430	430	
	3TF68 ¹⁾	630	630	630	502	502	502	440	440	440	408	408	408	
	3TF69 ¹⁾	630	630	630	630	630	630	572	572	572	531	531	531	

1) Contactor cannot be mounted.

SIMOCODE 3UF Motor Management and Control Devices

SIMOCODE pro 3UF7 motor management and control devices

Current measuring modules or current/voltage measuring modules	Contactors	CLASS 30			CLASS 35			CLASS 40			Fuse links ¹⁾	
		Rated operational current $I_e/AC-3$ in A at ... V									Types of coordination ²⁾	
		400 V			500 V			690 V			1	2
Types		400 V	500 V	690 V	400 V	500 V	690 V	400 V	500 V	690 V	690 V	690 V
Set current 0.3 ... 3.0 A												
3UF7 1 . 0-1AA00-0	3RT10 15	3.0	3.0	3.0	3.0	3.0	3.0	3.0	3.0	3.0	35	20
	3RT10 16	3.0	3.0	3.0	3.0	3.0	3.0	3.0	3.0	3.0	35	20
Set current 2.4 ... 25 A												
3UF7 1 . 1-1AA00-0	3RT10 15	7.0	5.0	4.0	7.0	5.0	4.0	7.0	5.0	4.0	35	20
	3RT10 16	9.0	6.5	5.2	9.0	6.5	5.2	8.5	6.5	5.2	35	20
	3RT10 17	9.0	9.0	6.3	9.0	9.0	6.3	8.5	8.5	6.3	35	20
	3RT10 23	--	--	--	--	--	--	--	--	--	63	25
	3RT10 24	12.0	12.0	9.0	12.0	12.0	9.0	12.0	12.0	9.0	63	25
	3RT10 25	14.0	14.0	13.0	13.0	13.0	13.0	12.0	12.0	12.0	63	25
	3RT10 26	14.0	14.0	13.0	13.0	13.0	13.0	12.0	12.0	12.0	100	35
	3RT10 34	19.1	19.1	19.1	17.6	17.6	17.6	16.1	16.1	16.1	125	63
	3RT10 35	25.0	25.0	24.0	25.0	25.0	24.0	23.5	23.5	23.5	125	63
	Set current 10 ... 100 A											
3UF7 1 . 2-1AA00-0	3RT10 34	19.1	19.1	19.1	17.6	17.6	17.6	16.1	16.1	16.1	125	63
	3RT10 35	26.5	26.5	24.0	25.0	25.0	24.0	23.5	23.5	23.5	125	63
	3RT10 36	26.5	26.5	24.0	25.0	25.0	24.0	23.5	23.5	23.5	160	80
	3RT10 44	41.7	41.7	41.7	38.2	38.2	38.2	34.5	34.5	34.5	200	125
	3RT10 45	45.0	45.0	45.0	43.0	43.0	43.0	40.0	40.0	40.0	200	160
	3RT10 46	50.0	50.0	50.0	47.0	47.0	47.0	44.0	44.0	44.0	200	160
	3RT10 54	69.0	69.0	69.0	63.0	63.0	63.0	57.0	57.0	57.0	355	315
	3RT10 55	90.0	90.0	90.0	82.0	82.0	82.0	74.0	74.0	74.0	355	315
	Set current 20 ... 200 A											
3UF7 1 . 3-1 . A00-0	3RT10 54	69.0	69.0	69.0	64.0	64.0	64.0	--	--	--	355	315
	3RT10 55	90	90	90	82	82	82	74	74	74	355	315
	3RT10 56	111	111	111	102	102	102	93	93	93	355	315
Set current 63 ... 630 A												
3UF7 1 . 4-1BA00-0	3RT10 64	135	135	135	126	126	126	--	--	--	500	400
	3RT10 65	159	159	159	146	146	146	133	133	133	500	400
	3RT10 66	180	180	180	165	165	165	150	150	150	500	400
	3RT10 75	240	240	240	220	220	220	200	200	200	630	400
	3RT10 76	300	300	300	275	275	275	250	250	250	630	500
	3RT12 64	173	173	173	152	152	152	131	131	131	500	500
	3RT12 65	204	204	204	180	180	180	156	156	156	500	500
	3RT12 66	231	231	231	204	204	204	177	177	177	500	500
	3RT12 75	316	316	316	--	--	--	--	--	--	800	800
	3RT12 76	385	385	385	340	340	340	316	316	316	800	800
	3TF68 ³⁾	376	376	376	344	344	344	317	317	317	800	500 ⁴⁾
	3TF69 ³⁾	500	500	500	469	469	469	438	438	438	800	630 ⁴⁾

1) Note the operational voltage.

2) Assignment and short-circuit protective devices acc. to IEC 60947-4-1.

Type of coordination "1": Contactors or starters must not endanger persons or equipment in the event of a short-circuit. They do not have to be suitable for further operation without repair and the renewal of parts.

Type of coordination "2": Contactors or starters must not endanger persons or equipment in the event of a short-circuit and must be suitable for continued use. There is a risk of contact welding.

3) Contactor cannot be mounted.

4) Please ensure that the maximum AC-3 operational current has a sufficient safety clearance from the rated fuse current.

Dimension drawings

Basic unit 1, SIMOCODE pro C, 3UF7 000

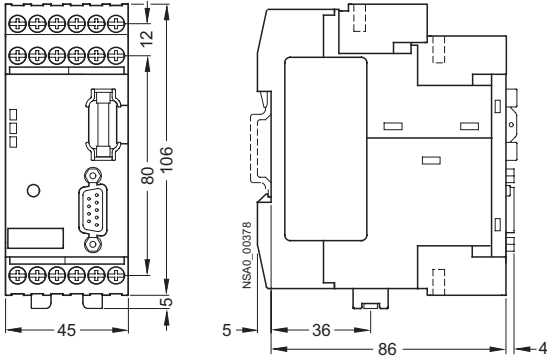

Basic unit 2, SIMOCODE pro V, 3UF7 010

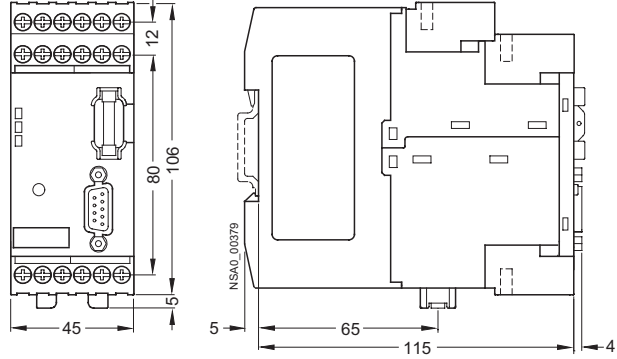

3UF7 100, 3UF7 101 current measuring module (straight-through transformer)

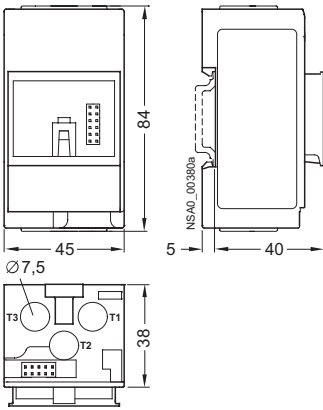

3UF7 102 current measuring module (straight-through transformer)

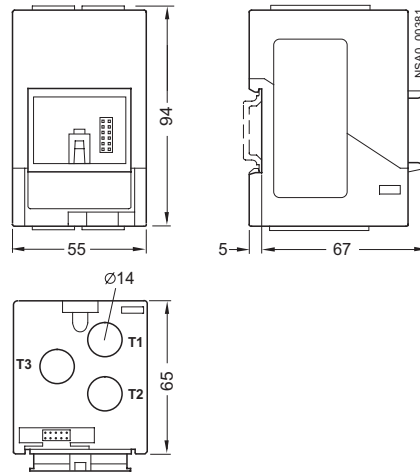

3UF7 103 current measuring module (straight-through transformer)

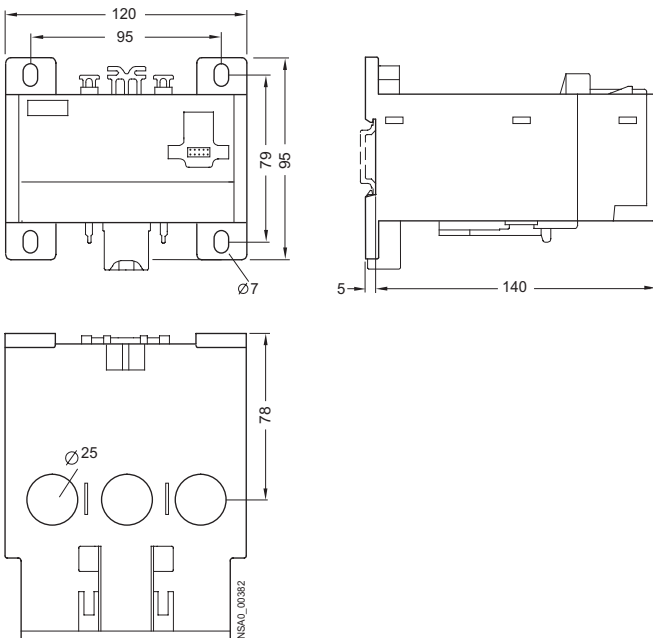

SIMOCODE pro 3UF7 motor management and control devices

3UF7 103 current measuring module (busbar connection)

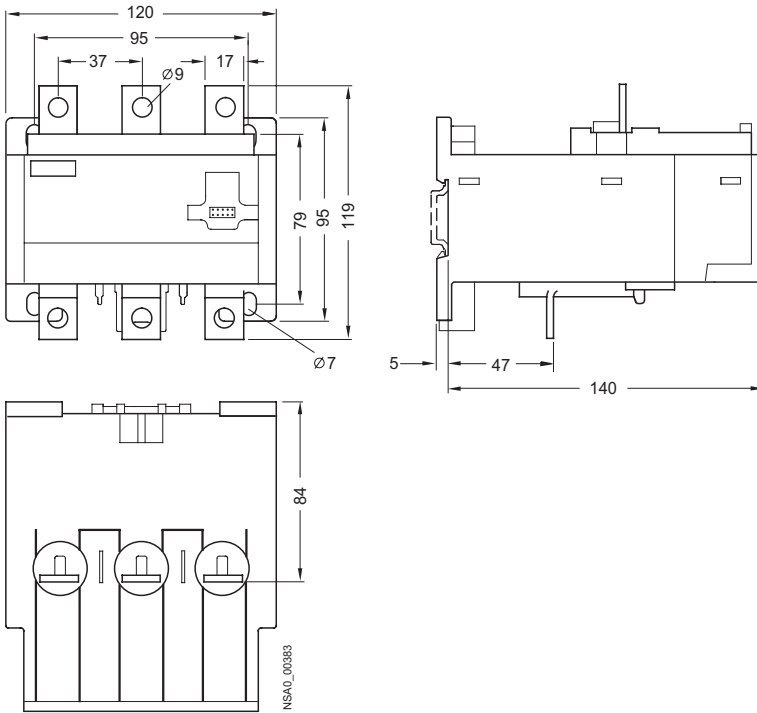

3UF7 104 current measuring module (busbar connection)

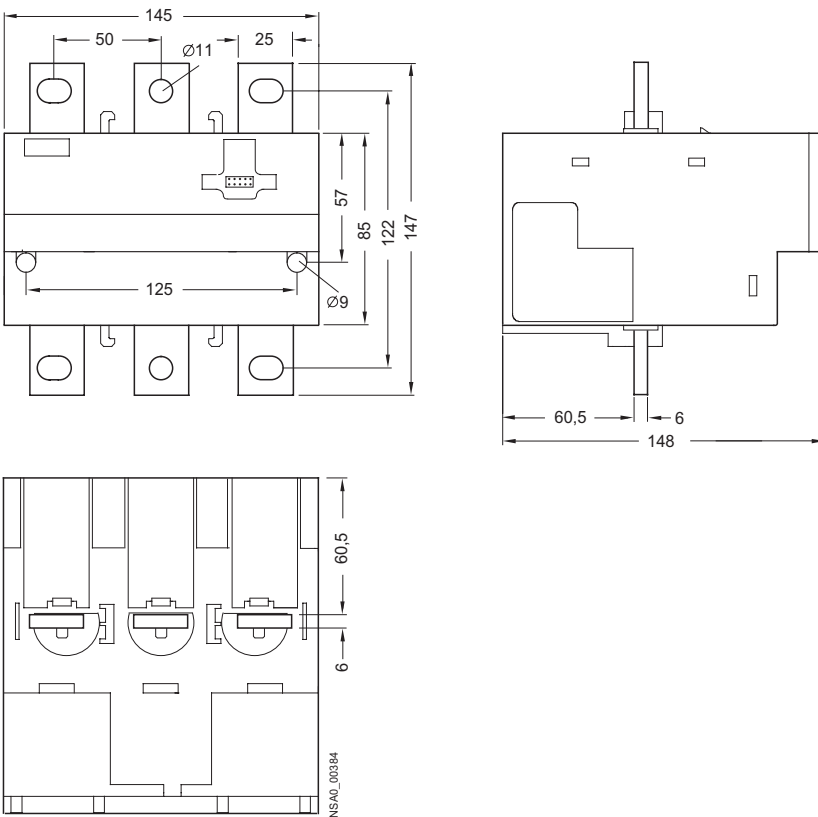

7

SIMOCODE pro 3UF7 motor management and control devices

3UF7 110, 3UF7 111 current/voltage measuring module (straight-through transformer)

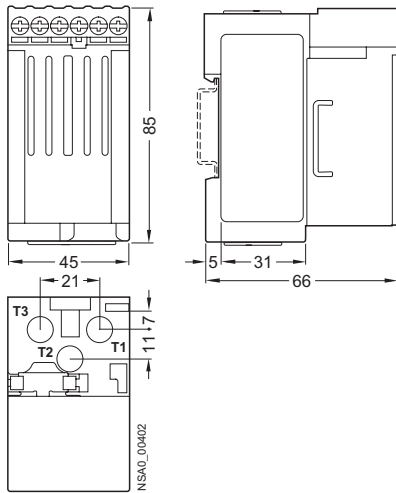

3UF7 112 current/voltage measuring module (straight-through transformer)

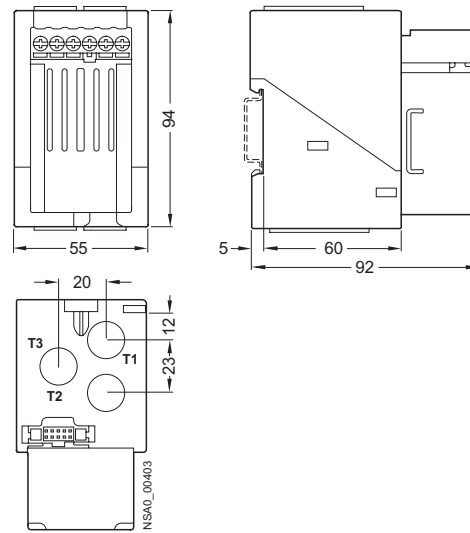

3UF7 113 current/voltage measuring module (straight-through transformer)

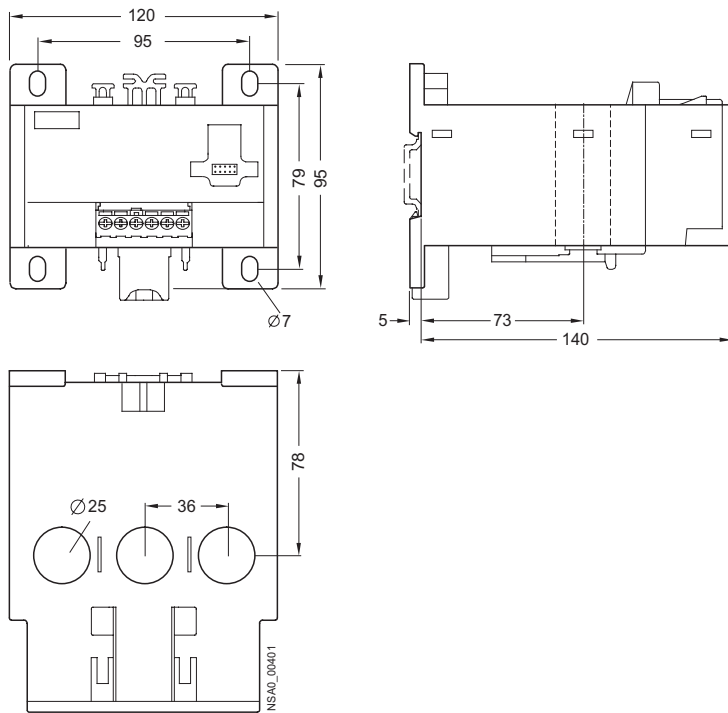

SIMOCODE 3UF Motor Management and Control Devices

SIMOCODE pro 3UF7 motor management and control devices

3UF7 113 current/voltage measuring module (busbar connection)

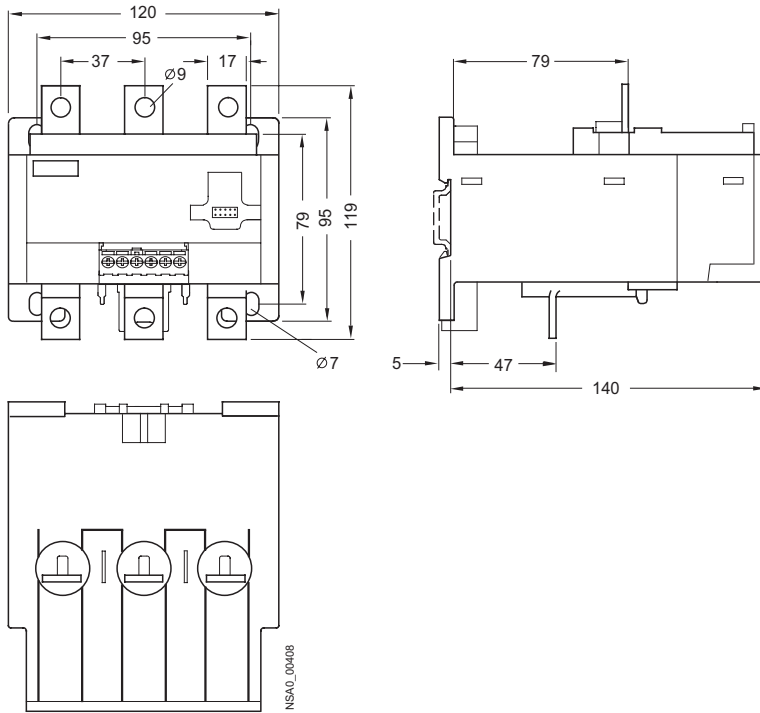

3UF7 114 current/voltage measuring module (busbar connection)

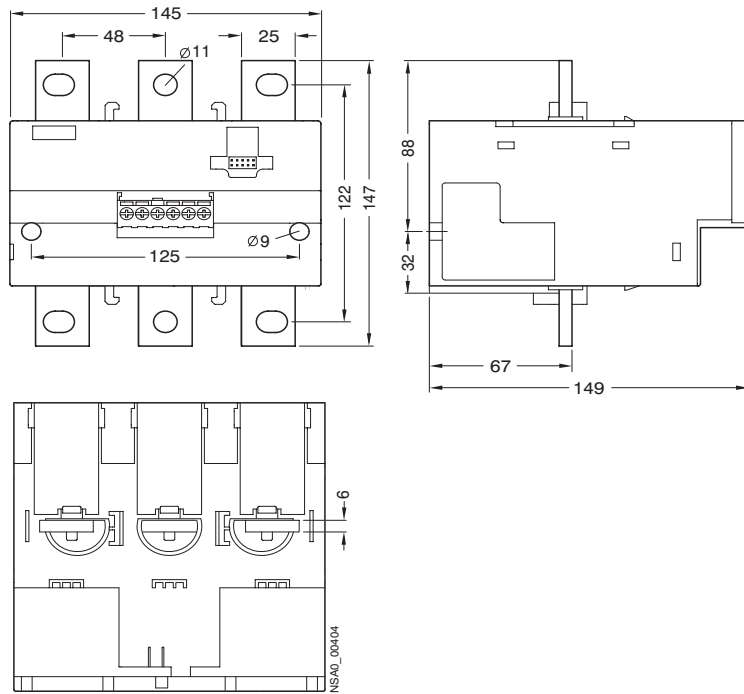

3UF7 200 operator panel

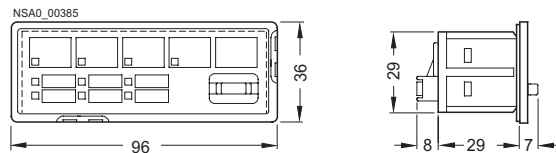

3UF7 920 door adapter

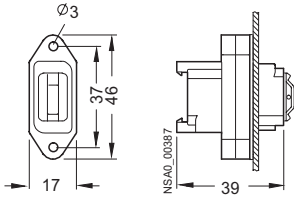

- 3UF7 3 digital modules
- 3UF7 4 analog module
- 3UF7 5 ground fault module
- 3UF7 7 temperature module

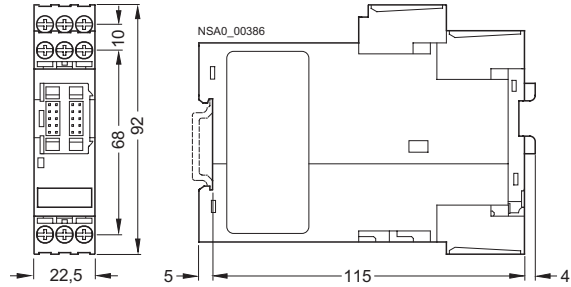

Schematics

Reversing starter with SIMOCODE pro

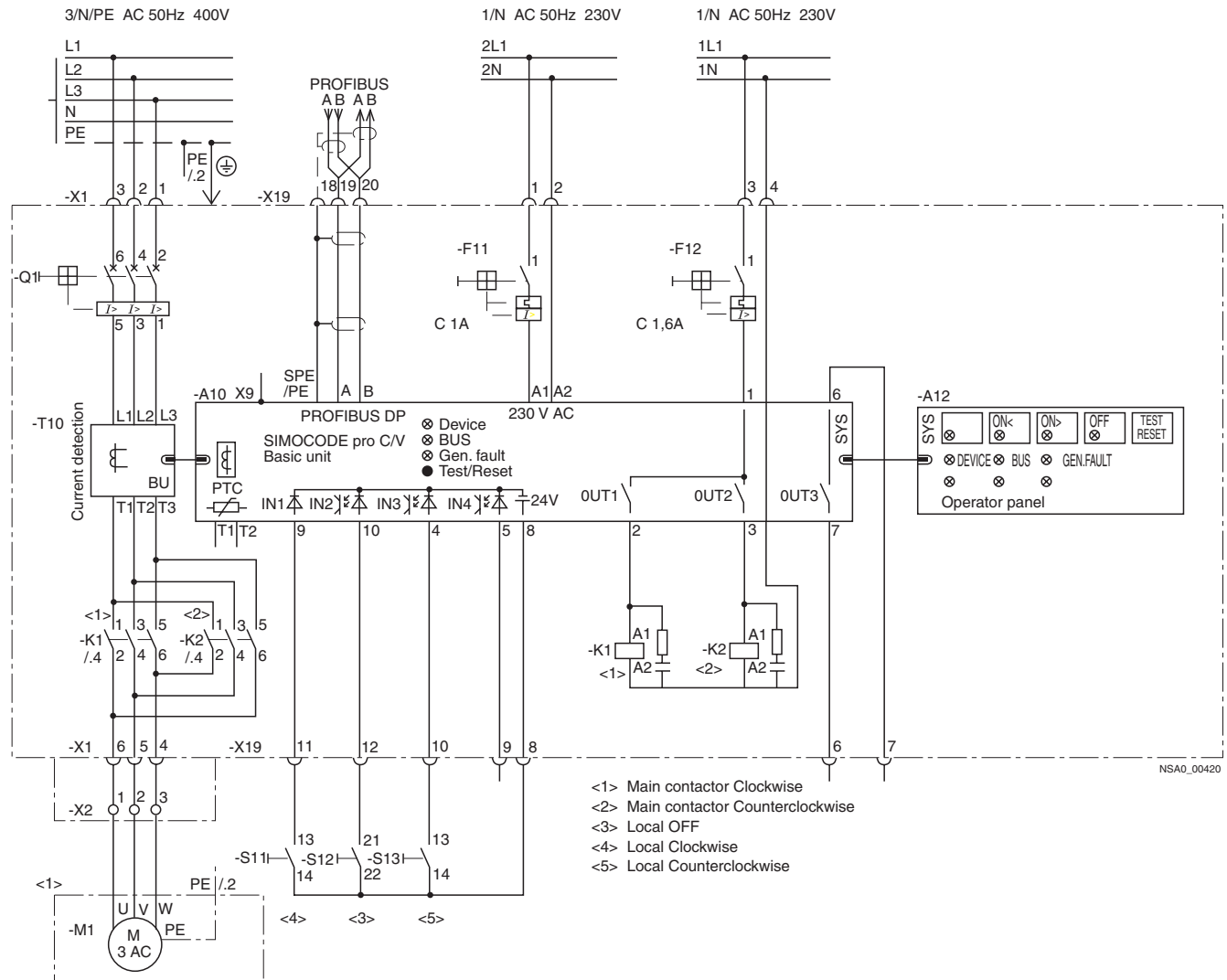

Circuit diagrams for additional control functions can be referred to in the SIMOCODE pro system manual.

More information

System manual

For selection of equipment and for planning, it is recommended that the 3UF7 970-0AA0.-0 system manual is consulted.

Internet

You can find more information on the Internet at: <http://www.siemens.com/simocode>

SIMOCODE-DP 3UF5 motor protection and control devices

Overview



SIMOCODE-DP basic unit, expansion module and operator module

SIMOCODE-DP is the predecessor of the SIMOCODE pro motor management system and offers the solution for a wide range of different tasks in a single unit:

- Multifunctional, electronic motor protection and plant monitoring
- Comprehensive motor and plant diagnostics
- Integrated control programs (instead of extensive hardware wiring)
- Open communication through PROFIBUS DP, the standard for fieldbus systems

Expansion module

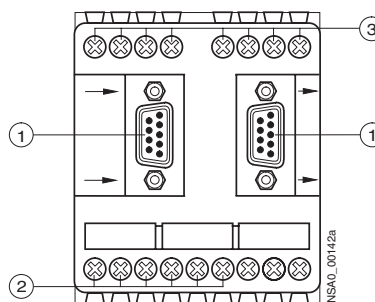

- ① PC/system interface
- ② Four relay outputs, floating
- ③ Eight inputs (24 V, 115 V, 230 V)

Front view of expansion module

Operator panel

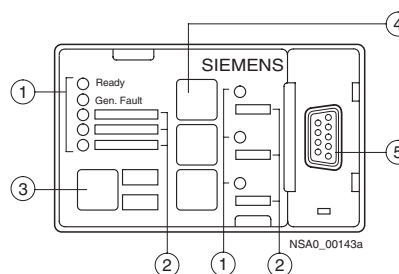

- ① Eight LEDs
- ② Labeling strips
- ③ Test/reset button for device test or manual reset
- ④ Three control keys
- ⑤ PC/system interface, with cover

Front view of operator panel

Design

The SIMOCODE-DP system hardware comprises:

- Basic unit
- Expansion module (optional)
- Operator panel (optional)

Basic unit

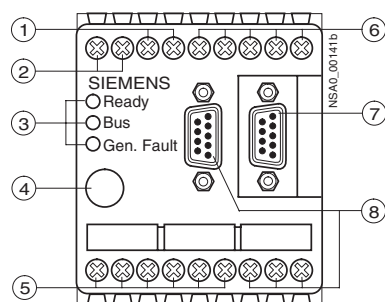

- ① Connection of thermistor of summation transformer
- ② Connection of control supply voltage
- ③ Three LEDs
- ④ Test/reset button for device test or manual reset
- ⑤ Four relay outputs, floating
- ⑥ Four inputs (24 V)
- ⑦ PC/system interface
- ⑧ PROFIBUS DP interface

Front view of the basic unit

Safe isolation

All electric circuits in SIMOCODE-DP (from product version 12, start of delivery 01/2000) are safely isolated from each other. The instructions of test report No. 1610a must be complied with.

Connection and mounting

Devices with current adjustment ranges from 1.25 to 100 A (overall width 70 mm) are designed for stand-alone installation due to the straight-through current transformer, i.e. they are either snapped onto a 35 mm standard mounting rail or screwed onto a mounting plate using push-in lugs that are available as accessories.

The main conductors are simply passed through the straight-through current transformer integrated into the enclosure, using multiple loops, loads with rated motor currents of less than 1.25 A can also be protected.

With current adjustment ranges greater than 100 A to 820 A (width: 120 mm, 145 mm and 230 mm), the devices can be directly fitted to the contactor using the connecting rails of the current transformer.

A screw fastening for these devices is integrated in the enclosure.

Function

Protective and monitoring functions

For the protection of loads against impermissible high temperature rises

Types of overload protection:

- **Current-sensitive, electronic overload protection with adjustable tripping characteristics (class times)**
SIMOCODE-DP protects three-phase or AC motors from overloading according to the requirements of IEC 60947-4-1. The class (trip class) indicates the maximum tripping time during which SIMOCODE-DP must trip at 7.2 times the operational current from cold. The trip class can be set in six stages from Class 5 to Class 30. The break time can therefore be extremely finely adjusted to the load torque of the motor – to optimize utilization of the motor (see also the section *Characteristic Curves*).
- **Phase failure/unbalance monitoring**
A signal is output for a phase unbalance greater than 40 %. The tripping times of the overload characteristic are reduced, because the heat generated in the motor rises under unbalanced conditions (additional eddy-current losses).
- **Thermistor motor protection**
Temperature-dependent motor protection is based on direct temperature measurements in the motor. These protective functions should be used, in particular, in motors with high operating frequencies, heavy-duty starting, intermittent and/or braking operation, but also in the case of a blocked air supply or speeds lower than the rated speed. For this reason, a wide range of different temperature sensors are available that are installed in the stator winding or in the motor enclosure. SIMOCODE-DP can evaluate the following sensor types:
 - Binary PTC sensors whose resistance rises sharply when the temperature limit is reached
 - Analog temperature sensors, such as NTC, KTY83/84, which have an almost linear characteristic curve and can therefore be set to any warning or switch-off temperatures

EEx e type of protection

The SIMOCODE-DP system is in compliance with the regulations for overload protection of explosion-protected motors of the EEx e "Increased safety" type of protection according to

- EN 50019
- EN 60079-7, IEC 60079-7
- EN 60079-14 (potentially explosive areas)
- EN 50281 (areas with combustible dust)
- ATEX/PTB test regulations

In the case of SIMOCODE-DP units with 24 V DC control infeed, isolation by battery or safety transformer according to EN 61558-2-6 must be assured.

EC type test certificate: PTB01 ATEX 3219

Test report: PTB EX 01-30013

Rotor locking protection

When the motor current rises above a rotor locking threshold that can be set, SIMOCODE-DP does not trip according to the overload characteristic, but switches off immediately instead. The prevention of unnecessary thermal loads prevents premature aging of the motor. The rotor locking protection is not active for start-up monitoring until the class time has elapsed, e.g. for *Class 10* after 10 seconds.

Ground-fault monitoring

Two qualitatively different ground-fault monitoring functions are offered:

- **"Internal" ground-fault monitoring by means of calculation**
The internal ground-fault monitoring is only suitable for motors with 3-wire connection and for networks that are grounded directly or with a low impedance. In this case, the ground-fault current is calculated by vector addition of the phase currents of the SIMOCODE-DP current transformer. An additional summation current transformer is not necessary. In fault-free systems, the vectorial summation current of the three phases is zero; if this is not the case, a ground-fault is signaled. Ground-fault currents that are more than 30 % of the operating current I_{ϕ} are detected.
- **"Internal" ground-fault monitoring by means of measurement**
The external ground-fault detection is normally used in supply systems that have a high impedance ground. An additional summation current transformer (3UL2 20.-.A) is required for this method that is also suitable for extremely low ground-fault currents. Detected fault current, depending on the summation current transformer: 0.3/0.5/1 A.

Current limit monitoring $I>$, $I<$

Current limit monitoring is not used for motor protection, but for process monitoring.

It is used to detect developing irregularities in the plant early, e.g. motor bearings becoming tight (consequence: upper limit responds) or the belt coupling to the drive machine tears (consequence: lower limit responds).

Comprehensive motor and plant diagnostics

SIMOCODE-DP provides a variety of measuring, operating and diagnostics data concerning the load feeder:

- **Up-to-date information during operation, e.g.:**
 - The currently flowing phase current in %
 - The switching state of the motor (On, Off, clockwise, counterclockwise, fast, slow) derived from the current flow
 - Manual/automatic mode
 - Test mode
 - Cooling time activated after an overload tripping operation
- **Detection of incipient faults, e.g.:**
 - Overload warning
 - Current limit overshoot
 - Phase unbalance
 - Thermistor warning
- **Rapid diagnostics in the event of an alarm, e.g.:**
 - Overload
 - Thermistor motor protection
 - Rotor locking
 - Current limit overshoot
 - Checkback error (e.g. no current following On command)
- **Preventive maintenance by means of statistical data, e.g.:**
 - Number of starts
 - Number of overload trips
 - Tripping currents
 - Operating hours

Integrated standard programs for motor control

In SIMOCODE-DP, a number of different opportunities for controlling the motor has been predefined and can be called up in the form of control functions:

- Overload relay
- Direct-on-line starter
- Reversing starter
- Wye-delta starter

SIMOCODE-DP 3UF5 motor protection and control devices

- Two speeds, Dahlander winding
- Two speeds, separate winding
- Valve
- Actuator
- Soft starter (3RW)

These control programs already include all the software interlocks and logic operations required for operation of the required motor functions.

It is also monitored whether the current checkback of the motor feeder corresponds with the control command. If not, SIMOCODE-DP opens the motor contactor and generates an alarm indication.

The motor can be controlled by any equipment depending on the application:

- From the process control system or the PC through PROFIBUS DP
- From the control cabinet door through the operator panel
- From a local control point on the motor, whereby the pushbuttons/switches are wired to the SIMOCODE-DP inputs

The standard control functions can also be adapted to each customized variant of a motor feeder by means of freely-parameterizable elements, such as timers, counters, logic operations (AND, OR, NOR, etc.).

Furthermore, special standard function blocks are stored in SIMOCODE-DP:

- *Automatic, time-discrete reactivation of motors following mains failure*
The prerequisites are as follows:
 - Failure of the three-phase supply must take place through a separate voltage relay
 - The supply voltage of SIMOCODE-DP must not be interrupted
- *Different error signaling modules with and without acknowledgement*
These allow SIMOCODE-DP to trip as a result of external events (e.g. overspeed monitor has tripped)
- *The emergency start function*
This resets the thermal memory of SIMOCODE-DP immediately after overload tripping, i.e. immediate restarting is possible (important, for example, for a fire-extinguisher pump)
- *The test function for the load feeder*
This can be activated by switching off the main switch Q1 (see the section *Schematics*) and allows the control circuit to be checked with the motor branch at zero current.

Integration

The SIMOCODE-DP modular system offers a wide range of software packages for system-wide and time-saving configuration and diagnostics:

- PC software Win-SIMOCODE-DP for start-up and service
- Object manager OM-SIMOCODE for "totally integrated" in SIMATIC S7
- Function block FB-SIMOCODE for "totally integrated" in PCS7

PC software Win-SIMOCODE-DP for start-up and service

Standard PC software Win-SIMOCODE-DP for start-up and service. It offers a user-friendly and convenient user-interface for:

- Parameterization
- Display and diagnostics
- Test functions
- Motor control

Win-SIMOCODE-DP is available in two versions:

- *Win-SIMOCODE-DP/Smart*
for direct connection to SIMOCODE-DP through the system interface on the device
- *Win-SIMOCODE-DP/Professional*
for direct connection to SIMOCODE-DP over PROFIBUS or directly through the system interface on the device

OM-SIMOCODE object manager for "totally integrated" in SIMATIC S7

SIMOCODE-DP can be integrated into SIMATIC S7 in two different ways:

- *Conventionally using GSD files*
i.e. integration in SIMATIC S7 is identical to integration in any other DP standard master system

- *Using the OM-SIMOCODE-DP object manager*
i.e. SIMOCODE-DP becomes an integral component of STEP 7; the OM-SIMOCODE-DP object manager should, in this case, always be combined with the start-up and service software Win-SIMOCODE-DP/Professional

Both software packages must be installed on the PG/PC on which the hardware configuration of SIMATIC S7 is performed. This ensures that Win-SIMOCODE-DP/Professional can be called up directly from HW-Config.

Parameter sets created with Win-SIMOCODE-DP/Professional are loaded into the STEP 7 data storage by means of OM and automatically transferred to SIMOCODE-DP during start-up.

Functions specific to SIMATIC S7, such as diagnostic and hardware interrupts are supported, which means easier S7-wide configuration as well as optimal performance in the transfer of diagnostic data.

Function block FB-SIMOCODE for "totally integrated" in PCS7

With PCS7-FB SIMOCODE-DP it is easy and convenient to integrate SIMOCODE-DP into the SIMATIC PCS 7 process control system. PCS7-FB SIMOCODE-DP contains the diagnostic and driver blocks corresponding with the diagnostic and driver concept of SIMATIC PCS 7 as well as the elements (symbols and faceplate) required for operator control and process monitoring. The application is integrated by graphic interconnection using the CFC Editor. The technological and signal processing functions of the PCS7-FB SIMOCODE-DP are based on the SIMATIC PCS 7 standard libraries (driver blocks, technological blocks) and are optimally tailored to SIMOCODE-DP. Users who previously configured motor feeder circuits using conventional technology by means of signal blocks and motor or valve blocks, can now easily switch to PCS7-FB SIMOCODE-DP. The PCS7-FB SIMOCODE-DP supplied on CD-ROM allows the user to run the required engineering software on one engineering station (single license) including the runtime software for executing the AS blocks in an automation system (single license).

Technical specifications

Shared data of basic units/expansion units/ expansion modules/operator panels		
Permissible ambient temperature	°C	-25 ... +60
Permissible storage temperature	°C	-40 ... +80
Installation altitude above sea level	m	≤ 2000
Degree of protection (acc. to IEC 60529)		IP20 max. set current $I_e \leq 100$ A; IP00 max. set current $I_e > 100$ A
Shock resistance (sine pulse)	g/ms	10/5
Mounting position		Any
Mounting		
• Max. set current $I_e \leq 100$ A		Snap-on mounting onto 35 mm standard mounting rail or screw fixing with push-in lugs
• Max. set current $I_e > 100$ A		Screw fixing directly onto contactor or screw fixing
EMC interference immunity		
• Conducted interference, burst acc. to IEC 61000-4-4	kV	2 (corresponds to degree of severity 3)
• Conducted interference, surge acc. to IEC 61000-4-5	kV	2 (corresponds to degree of severity 3)
• Electrostatic discharge acc. to IEC 61000-4-2	kV	8 (corresponds to degree of severity 3)
• Field-related interference acc. to IEC 61000-4-3	V/m	10 (corresponds to degree of severity 3)
EMC interference emission		Limit class B acc. to EN 55011 (VDE 0875 Part 11)
Safe isolation (product version 12 upwards, start of delivery 01/2000)		All electric circuits in SIMOCODE-DP are safely isolated from each other, i.e. they are designed with double leakage paths and clearances Power circuit from the control/electronic circuits: Safe isolation up to 690 V or 1000 V between control and electronic circuits One below the other: Safe isolation up to 300 V Observe notes of test report "Safe Isolation" No. 1610a.

Basic units

Displays		
• Green "Ready" LED		Continuous light: "Ready" Off: "No control supply voltage" or "Function test not OK; device is disabled"
• Green "BUS" LED		Continuous light: "Bus operation"
• Red "General Fault" LED		Continuous light/blinklight: "Feeder fault", e.g. overload tripping
Test/Reset buttons		By pressing the Test/Reset button, the device can be reset following a trip or its functions can be tested
System interfaces		RS 232 for connecting the expansion module, operator panel or PC
PROFIBUS DP interface		RS 485 for connecting the PROFIBUS DP line using terminals (conductor cross-sections as for auxiliary contacts) or 9-pole SUB D socket

Main circuits

Rated insulation voltage U_i (with pollution degree 3)			
• For uninsulated conductors (3UF5 001 to 3UF5 021)	V	690	
• For insulated conductors (3UF5 001 to 3UF5 021)	V	1000	
• For uninsulated and insulated conductors (3UF5 031 to 3UF5 051)	V	1000	
Rated impulse withstand voltage U_{imp}			
• 3UF5 001 to 3UF5 021	kV	6	
• 3UF5 031 to 3UF5 051	kV	8	
Rated frequency	Hz	50/60	
Type of current		Three-phase current	
Short-circuit protection		See table <i>Short-circuit protection with fuses for motor feeders, page 7/31</i>	
Diameters of feed-through openings (max. $I_e = 100$ A)			
• Devices with max. set current $I_e \leq 25$ A	mm	10	
• Devices with max. set current $I_e \leq 100$ A	mm	15	
• Devices with max. set current $I_e > 100$ A		Design with connecting bars	
Busbar connections			
• Current range	A	50 ... 205	125 ... 500
• Tightening torque	Nm	M 8: 10 ... 14	M 10: 14 ... 24
			M 12: 20 ... 35
• Finely stranded with cable lug	mm ²	35 ... 95	50 ... 240
• Stranded with cable lug	mm ²	50 ... 120	70 ... 240



SIMOCODE 3UF Motor Management and Control Devices

SIMOCODE-DP 3UF5 motor protection and control devices

Auxiliary circuits/control circuits

Rated control supply voltage U_s		AC 50/60 Hz; 115 V and 230 V	24 V DC
Operating range		AC 50/60 Hz 0.85 ... 1.1 x U_s	24 V DC; 0.85 ... 1.2 x U_s
Power input		AC 50/60 Hz; 5 VA	24 V DC; 5 W
Rated insulation voltage U_i	V	300 (at pollution degree 3)	
Rated impulse withstand voltage U_{imp}	kV	4	
Outputs			
<ul style="list-style-type: none"> • Number • Auxiliary contacts of the 4 outputs 			4 monostable/bistable outputs depending on the variant NC contact response can be parameterized by means of internal signal conditioning; 3 outputs jointly and 1 separately connected to common potential; they can be freely assigned to the control functions (e.g. for activating mains, wye and delta contactors and signaling the operating status)
<ul style="list-style-type: none"> • Specified short-circuit protection for auxiliary contacts (outputs) 			Fuse links, gL/gA operational class 6 A, quick 10 A; circuit-breaker 1.6 A, C characteristic
Rated uninterrupted current	A	5	
Rated operational current (switching capacity)		AC-15; 6 A/24 V; 6 A/120 V; 3 A/230 V DC-13; 2 A/24 V; 0.55 A/60 V; 0.25 A/125 V	
Inputs			4 inputs, supplied by the device electronics (24 V DC), jointly connected to a common potential, for injecting process signals such as local control points, key-operated switches or limit switches
Thermistor motor protection (binary PTC thermistor)			
<ul style="list-style-type: none"> • Summation cold resistance • Operating value • Return value 	k Ω	1.5 2.7 ... 3.1 1.5 ... 1.65	
Conductor cross-sections			
<ul style="list-style-type: none"> • Tightening torque • Solid and stranded • Finely stranded with or without end sleeve 	Nm mm ² mm ²	0.8 ... 1.2 1 x (0.5 ... 4.0); 2 x (0.5 ... 2.5) 1 x (0.5 ... 2.5); 2 x (0.5 ... 1.5)	

Expansion modules

System interfaces			RS 232 as connection to the basic unit and for connecting the operator panel or PC
Rated insulation voltage U_i	V	300 (at pollution degree 3)	
Rated impulse withstand voltage U_{imp}	kV	4	
Outputs			
<ul style="list-style-type: none"> • Number • Auxiliary contacts of the 4 outputs 			4 bistable outputs Each with 1 floating NO contact, NC contact response can be parameterized with internal signal conditioning, 3 outputs are jointly and 1 is separately connected to a common potential; they can be freely assigned to the control functions (e.g. for activating mains, wye and delta contactors and for signaling the operating status)
<ul style="list-style-type: none"> • Specified short-circuit protection for auxiliary contacts (outputs) 			Fuse links, operational class gL/gA 6 A, quick 10 A; circuit-breaker 1.6 A, C characteristic
Rated uninterrupted current	A	5	
Rated operational current (switching capacity)		AC-15; 6 A/24 V; 6 A/120 V; 3 A/230 V DC-13; 2 A/24 V; 0.55 A/60 V; 0.25 A/125 V	
Inputs			8 externally supplied with 24 V DC, 115 V AC or 230 V AC depending on the variant, jointly connected to a common potential, for injecting process signals such as local control points, key-operated switches or limit switches
Conductor cross-sections			
<ul style="list-style-type: none"> • Tightening torque • Solid and stranded • Finely stranded with or without end sleeve 	Nm mm ² mm ²	0.8 ... 1.2 1 x (0.5 ... 4.0); 2 x (0.5 ... 2.5) 1 x (0.5 ... 2.5); 2 x (0.5 ... 1.5)	

Operator panels

Displays			
<ul style="list-style-type: none"> • Green "Ready" LED • Red "General Fault" LED • 3 green and 3 yellow LEDs 			Continuous light: "Ready" Off: "No control supply voltage" or "Function test not OK; device is disabled" Continuous light/blinklight: "Feeder fault", e.g. overload tripping Feeder-specific displays, freely-assignable, e.g. manual/automatic mode, tripping of thermistor protection, clockwise/counterclockwise rotation etc.
Keys			
<ul style="list-style-type: none"> • Test/Reset • Control keys 			by pressing the Test/Reset button, the device can be reset following a trip or its functions can be tested for controlling the motor feeder, freely programmable
System interfaces			RS 232 as connection to the basic unit, to the expansion module and for connection to PC

SIMOCODE 3UF Motor Management and Control Devices

SIMOCODE-DP 3UF5 motor protection and control devices

Short-circuit protection with fuses for motor feeders
with short-circuit currents up to 50 kA at 690 V for 3RB1 2 and 3UF5 0, Part 1

Basic units	Contactors	Class 5 and 10			Class 15			Class 20			Class 25			Class 30		
		Rated operational current I_e AC-3 in A at ... V														
		400	500	690	400	500	690	400	500	690	400	500	690	400	500	690
Setting range 1.25 ... 6.3 A																
3UF5 00	3RT1 015	6.3	5.0	4.0	6.3	5.0	4.0	6.3	5.0	4.0	6.3	5.0	4.0	6.3	5.0	4.0
	3RT1 016	6.3	6.3	5.2	6.3	6.3	5.2	6.3	6.3	5.2	6.3	6.3	5.2	6.3	6.3	5.2
	3RT1 017	6.3	6.3	6.3	6.3	6.3	6.3	6.3	6.3	6.3	6.3	6.3	6.3	6.3	6.3	6.3
Setting range 6.3 ... 25 A																
3UF5 01	3RT1 015	7.0			7.0			7.0			7.0			7.0		
	3RT1 016	9.0	6.5		9.0	6.5		9.0	6.5		9.0	6.5		9.0	6.5	
	3RT1 017	12.0	9.0	6.3	11.0	9.0	6.3	10.0	9.0	6.3	9.5	9.0	6.3	9.0	9.0	6.3
	3RT1 024	12.0	12.0	9.0	12.0	12.0	9.0	12.0	12.0	9.0	12.0	12.0	9.0	12.0	12.0	9.0
	3RT1 025	17.0	17.0	13.0	17.0	17.0	13.0	16.0	16.0	13.0	15.0	15.0	13.0	14.0	14.0	13.0
	3RT1 026	25.0	18.0	13.0	18.0	18.0	13.0	16.0	16.0	13.0	15.0	15.0	13.0	14.0	14.0	13.0
	3RT1 034	25.0	25.0	20.0	25.0	25.0	20.0	22.3	22.3	20.0	20.3	20.3	20.3	19.1	19.1	19.1
	3RT1 035	25.0	25.0	24.0	25.0	25.0	24.0	25.0	25.0	24.0	25.0	25.0	24.0	25.0	25.0	24.0
Setting range 25 ... 100 A																
3UF5 02	3RT1 034	32.0	32.0	20.0	25.5	25.5	20.0	22.3	22.3	20.0	20.3	20.3	20.0	19.1	19.1	19.1
	3RT1 035	40.0	40.0	24.0	33.0	33.0	24.0	29.4	29.4	24.0	28.0	28.0	24.0	26.5	26.5	24.0
	3RT1 036	50.0	50.0	24.0	38.5	38.5	24.0	32.7	32.7	24.0	29.4	29.4	24.0	26.5	26.5	24.0
	3RT1 044	65.0	65.0	47.0	56.0	56.0	47.0	49.0	49.0	47.0	45.0	45.0	45.0	41.7	41.7	41.7
	3RT1 045	80	80	58	61	61	58	53	53	53	47	47	47	45	45	45
	3RT1 046	95	95	58	69	69	58	59	59	58	53	53	53	50	50	50
Setting range 50 ... 205 A																
3UF5 03	3RT1 054	115	115	115	93	93	93	82	82	82	75	75	75	69	69	69
	3RT1 055	150	150	150	122	122	122	107	107	107	98	98	98	90	90	90
	3RT1 056	185	185	170	150	150	150	131	131	131	120	120	120	111	111	111
Setting range 125 ... 500 A																
3UF5 04	3RT1 064	225	225	225	182	182	182	160	160	160	146	146	146	135	135	135
	3RT1 065	265	265	265	215	215	215	188	188	188	172	172	172	159	159	159
	3RT1 066	300	300	280	243	243	243	213	213	213	195	195	195	180	180	180
	3RT1 075	400	400	400	324	324	324	284	284	284	260	260	260	240	240	240
	3RT1 076	500	500	450	405	405	405	355	355	355	325	325	325	300	300	300
	3RT1 264	225	225	225	225	225	225	225	225	225	194	194	194	173	173	173
	3RT1 265	265	265	265	265	265	265	265	265	265	228	228	228	204	204	204
	3RT1 266	300	300	300	300	300	300	300	300	300	258	258	258	231	231	231
	3RT1 275	400	400	400	400	400	400	400	400	400	344	344	344	308	308	308
	3RT1 276	500	500	500	500	500	500	500	500	500	430	430	430	385	385	385
Setting range 200 ... 820 A																
3UF5 05	3TF6 8 ¹⁾	630	630	630	502	502	502	440	440	440	408	408	408	376	376	376
	3TF6 9 ¹⁾	820	820	820	662	662	662	572	572	572	531	531	531	500	500	500

1) Contactors mountable.



SIMOCODE 3UF Motor Management and Control Devices

SIMOCODE-DP 3UF5 motor protection and control devices

Short-circuit protection with fuses for motor feeders
with short-circuit currents up to 50 kA at 690 V for 3RB1 2 and 3UF5 0, Part 2

Basic units	Contactors	Fuse links ¹⁾				
		690 V LV HRC DIAZED NEOZED Operational class gL (gG) Type of coordination ²⁾ 1	Type 3NA Type 5SB Type 5SE 2	Type 3ND aM	415 V British Standards fuses BS88	600 V UL-listed fuses RK5/L 500
Setting range 1.25 ... 6.3 A						
3UF5 00	3RT1 015	35	20		20	25
	3RT1 016	35	20		20	25
	3RT1 017	35	20		20	25
Setting range 6.3 ... 25 A						
3UF5 01	3RT1 015	35	20		20	60
	3RT1 016	35	20		20	60
	3RT1 017	35	20		20	60
	3RT1 024	63	25	20	25	70
	3RT1 025	63	25	20	25	70
	3RT1 026	100	35	20	25	100
	3RT1 034	125	63	50	63	100
	3RT1 035	125	63	50	63	100
Setting range 25 ... 100 A						
3UF5 02	3RT1 034	125	63	50	63	125
	3RT1 035	125	63	50	80	150
	3RT1 036	160	80	50	80	200
	3RT1 044	250	125	63	125	250
	3RT1 045	250	160	80	160	250
	3RT1 046	250	160	100	160	350
Setting range 50 ... 205 A						
3UF5 03	3RT1 054	355	315	160	250	450
	3RT1 055	355	315	200	315	500
	3RT1 056	355	315	200	315	500
Setting range 125 ... 500 A						
3UF5 04	3RT1 064	500	400	250	400	700
	3RT1 065	500	400	315	400	800
	3RT1 066	500	400	315	400	800
	3RT1 075	630	400	400	450	1000
	3RT1 076	630	500	500	500	1200
	3RT1 264	500	500	400	450	800
	3RT1 265	500	500	400	450	800
	3RT1 266	500	500	400	450	800
	3RT1 275	800	800	630	800	1200
	3RT1 276	800	800	630	800	1200
	Setting range 200 ... 820 A					
3UF5 05	3TF6 8 ³⁾	1000	500 ⁴⁾	630	500	1200
	3TF6 9 ³⁾	1250	630 ⁴⁾	630	630	2000 CLASS L

1) Note the operational voltage.

2) Assignment and short-circuit protective devices
acc. to IEC 60947-4-1:

Type of coordination "1": Contactors or starters must not endanger persons or equipment in the event of a short-circuit. They do not have to be suitable for further operation without repair and the renewal of parts.

Type of coordination "2": Contactors or starters must not endanger persons or equipment in the event of a short-circuit and must be suitable for continued use. There is a risk of contact welding.

3) Contactors mountable.

4) Ensure that the maximum AC-3 operational current is sufficiently different from the rated fuse current.

Characteristic curves

Tripping characteristics for three-pole loads

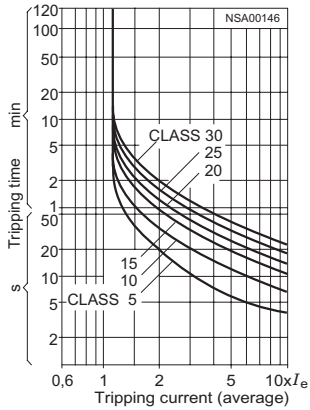

The current-time curves for 3-pole symmetrical load show the relationship between the release time from cold and multiples of the operational current.

If the device is pre-loaded with 100 % of the current setting, the tripping times are reduced.

Tripping characteristics for double-pole loads

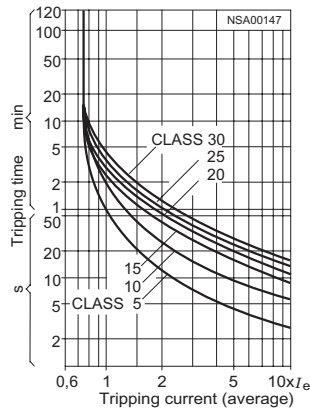

In the case of 2-pole loading (failure of one phase) or current unbalance > 40 % of the current setting, the tripping times are reduced, because the heat generated due to the unbalanced loading of the motor rises.

Dimensional drawings

3UF5 001, 3UF5 011 and 3UF5 021 basic units

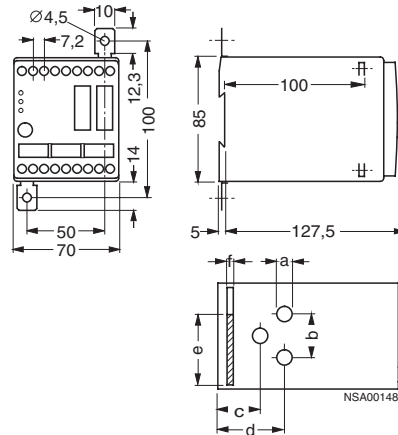

	a	b	c	d	e	f
3UF50 01	10	34	29	46	-	-
3UF50 11	10	34	29	46	48	4
3UF50 21	15	29	24	47	48	4

3UF5 031, 3UF5 041 and 3UF5 051 basic units

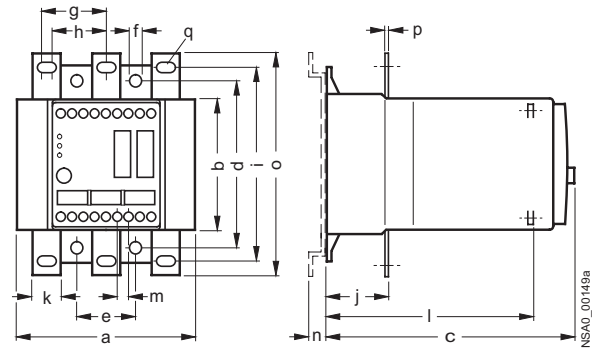

	a	b	c	d	e	f	g	h
3UF5 031	120	85	155	110	40	Ø 7	42	37
3UF5 041	145	85	175	105	50	Ø 9	52	48
3UF5 051	230	85	190	120	70	Ø 11	70	-

	i	j	k	l	m	n	o	p	q
3UF5 031	125	41	20	131	7,2	13	145	4	M 8
3UF5 041	130	46	30	151	7,2	-	160	6	M 10
3UF5 051	135	55	40	166	7,2	-	175	8	M 12



SIMOCODE 3UF Motor Management and Control Devices

SIMOCODE-DP 3UF5 motor protection and control devices

3UF5 1 expansion module

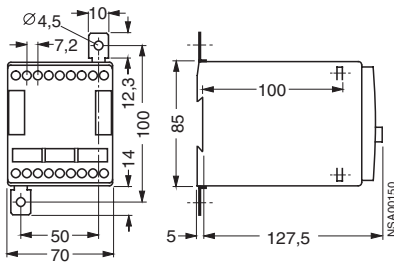

3UF5 2 operator panel

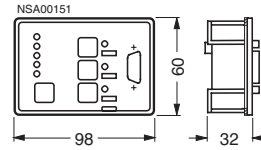

Schematics

Reversing starter

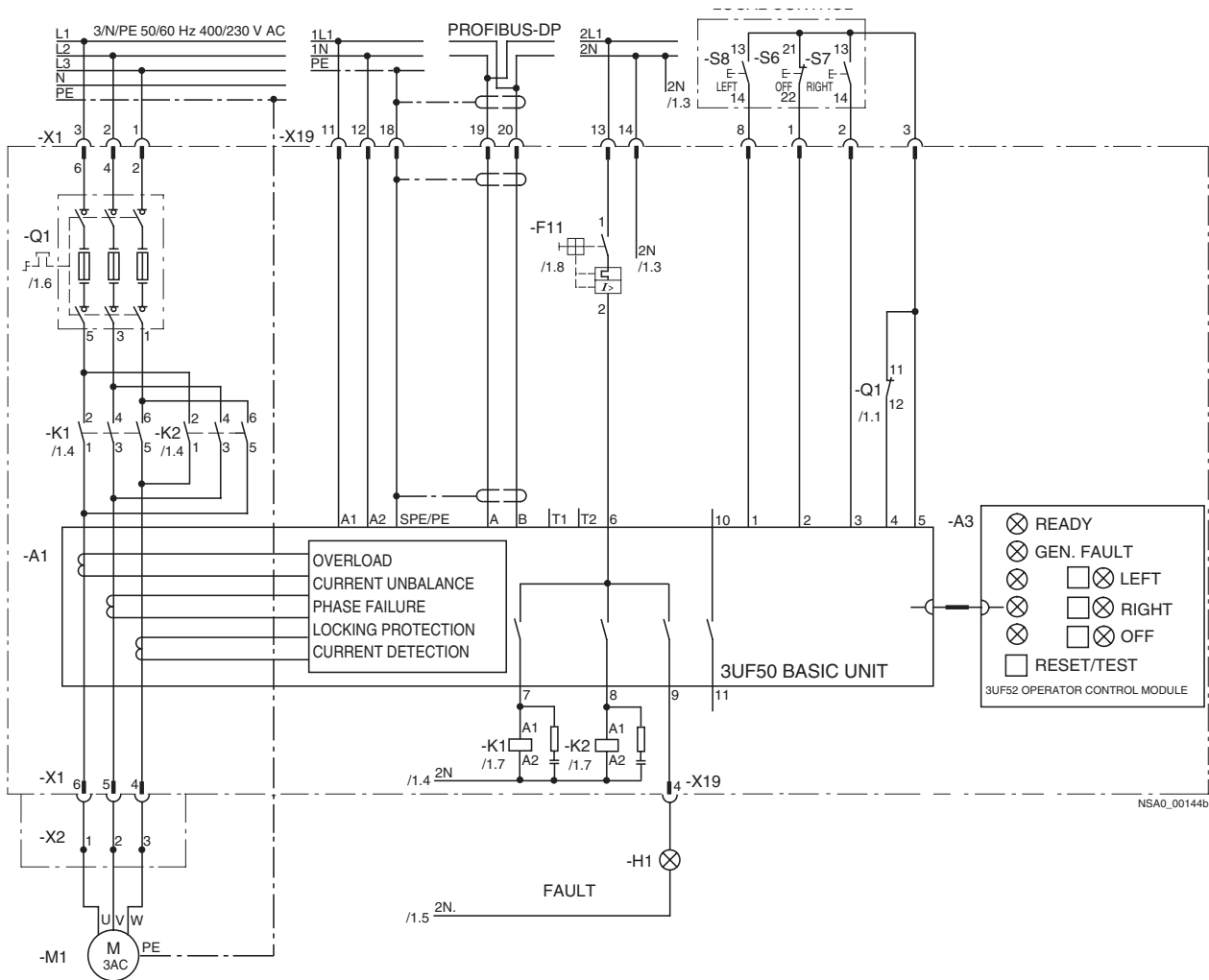

Further circuit diagrams for the control functions overload, direct online starter, wye-delta starter, pole reversing, Dahlander circuit, solenoid valve, gate valve (servo drives) and 3RW2 2 soft

starter and a configuration example are included in the 3UF5 7 system manual.

More information

System manual

For selection of equipment and for planning, it is recommended that the 3UF5 7 system manual is consulted.

Internet

You can find more information on the Internet at:

<http://www.siemens.com/simocode-dp>

Overview

The 3UF18 current transformers are protection transformers and are used for actuating overload relays. Protection transformers are designed to ensure proportional current transfer up to a

multiple of the primary rated current. The 3UF18 current transformers convert the maximum current of the corresponding operating range into the standard signal 1 A secondary.

Technical specifications

Climatic environmental conditions			
Temperatures			
• Operation	°C	-25 ... +60	
• Storage/transport	°C	-40 ... +85	
Temperature changes			
• Operation	°C/h	max. 10	
• Storage/transport	°C/h	max. 20	
Relative humidity	%	15 ... 95 (indoor, acc. to IEC 60721-3, no condensation)	
Air pressure			
• Operation	hPa	860 ... 1060	
• Storage/transport	hPa	650 ... 1060	
Contaminants			
• SO ₂	ppm	0.5 (relative humidity ≤ 60 %, no condensation)	
• H ₂ S	ppm	0.1 (relative humidity ≤ 60 %, no condensation)	
Mechanical environmental conditions			
Vibrations (acc. to IEC 60068-2-6)			
	Hz	10 ... 57 (for constant amplitude 0.15 nm)	
	Hz	57 ... 150 (for constant acceleration 2 g)	
Shock (acc. to IEC 60068-2-27)			
12 shocks (half sine 15 g/11 ms)			
Requirements acc. to IEC and DIN			
Degree of protection (acc. to IEC 60529)			
IP20			
Rated insulation voltage			
V 690/1000 (type-dependent)			
Rating of the insulation (acc. to UL/CSA)			
V 600			
Trip class (acc. to IEC 60947-4-1)			
Suitable from CLASS 5 to CLASS 30			
Power loss per conducting path of the transformers			
	Operating range	for setting ...	
		to the lower limit	to the upper limit
	A	mW (mVA)	mW (mVA)
• 3UF18 45	12.5 ... 50	33 (38)	570 (650)
• 3UF18 48	25 ... 100	110 (120)	1700 (1900)
• 3UF18 50	32 ... 130	135 (150)	2400 (2700)
• 3UF18 52	50 ... 200	170 (190)	2600 (2900)
• 3UF18 56	100 ... 400	450 (500)	6500 (7000)
• 3UF18 57	125 ... 500	850 (940)	13000 (15000)
• 3UF18 68-3F	160 ... 630	900 (1000)	17000 (19000)
• 3UF18 68-3G	205 ... 820	1400 (1600)	22000 (25000)
Conductor cross-sections (one or two conductors connectable)			
Current transformers			
		on secondary side	on primary side
			3UF18 45 3UF18 48 ¹⁾ 3UF18 50 ¹⁾ 3UF18 52 3UF18 56 3UF18 57 ²⁾ 3UF18 68-3FA00 ²⁾ 3UF18 68-3GA00 ²⁾
• Terminal screw		M 3.5	M 8 M 10 M 10 M 12
• Solid	mm ²	2 × 1.5 ... 2.5	-- -- -- --
• Stranded	mm ²	2 × 1.5 ... 2.5	-- -- -- --
• Finely stranded without end sleeve	mm ²	--	-- -- -- --
• Finely stranded with end sleeve	mm ²	2 × 1.5	-- -- -- --
• Finely stranded with cable lug	mm ²	--	35 ... 95 50 ... 240 ³⁾ 50 ... 240 185 ... 240
• Stranded with cable lug	mm ²	--	50 ... 120 70 ... 240 ³⁾ 70 ... 240 185 ... 240
• Connecting bars	mm	--	20 × 4 25 × 6.30 × 6 30 × 5 50 × 5
• Tightening torque	Nm	0.8 ... 1.4	10 ... 14 14 ... 24 14 ... 24 14 ... 24
• Tightening torque	lb	7 ... 12	89 ... 124 124 ... 210 124 ... 210 124 ... 210

1) With or without box terminal.

2) Conductor cross-sections for box terminals, see 3TF6 8 and 3TF6 9 contactors in the section Contactors and Contactor Assemblies.

3) With max. conductor cross-section, a terminal cover for maintaining the phase spacing is required.



3UF18 current transformers for overload protection

Short-circuit protection with fuses for motor feeders for short-circuit currents up to 50 kA at 690 V¹⁾, 50/60 Hz

Overload relays	Contactors	Rated operational current I _e AC-3 in A with 400 V and Class ...					Type of coordination ²⁾				
		5 and 10	15	20	25	30	1	2			
							Fuse links in A ³⁾				
							LV HRC, Type 3NA		NH TYPE	British	
							DIAZED, Type 5SB	3ND	Standards	fuses	
							NEOZED Type 5SE				
							gL/gG	aM	BS88		
Operating range 0.25 ... 2.5 A											
3UF18 43-1BA00	3RT1 015	2.5	2.5	2.5	2.5	2.5	25	10	--	--	
Operating range 1.25 ... 12.5 A											
3UF18 43-1AA00	3RT1 015	7	7	7	7	7	25	10	--	--	
	3RT1 016	9	9	9	9	9	25	10	--	--	
	3RT1 017	12	11	10	9.5	9	25	10	--	--	
	3RT1 024	12	12	12	12	12	35	16	20	35	
	3RT1 025	12.5	12.5	12.5	12.5	12.5	35	16	20	35	
Operating range 2.5 ... 25 A											
3UF18 43-2BA00	3RT1 015	7	7	7	7	7	25	10	--	--	
	3RT1 016	9	9	9	9	9	25	10	--	--	
	3RT1 017	12	11	10	9.5	9	25	10	--	--	
	3RT1 024	12	12	12	12	12	63	25	20	35	
	3RT1 025	17	17	16	15	14	63	25	20	35	
	3RT1 026	25	18	16	15	14	63	25	35	50	
	3RT1 034	--	25	22.3	20.3	19.1	63	25	--	--	
	3RT1 035	--	--	25	25	25	63	25	--	--	
Operating range 12.5 ... 50 A											
3UF18 45-2CA00	3RT1 025	17	17	16	15	14	63	25	20	35	
	3RT1 026	25	18	16	15	14	100	35	35	50	
	3RT1 034	32	25.5	22.3	20.3	19.1	100	63	--	--	
	3RT1 035	40	33	29.4	28	26.5	100	63	--	--	
	3RT1 036	50	38.5	32.7	29.4	26.5	100	80	--	--	
	3RT1 044	--	50	49	45	41.7	100	80	--	--	
	3RT1 045	--	--	50	47	45	100	80	--	--	
	3RT1 046	--	--	--	50	50	100	80	--	--	
Operating range 16 ... 65 A											
3UF18 47-2DA00	3RT1 034	32	25.5	22.3	20.3	19.1	125	63	--	--	
	3RT1 035	40	33	29.4	28	26.5	125	63	--	--	
	3RT1 036	50	38.5	32.7	29.4	26.5	160	80	--	--	
	3RT1 044	65	56	49	45	41.7	160	125	--	--	
	3RT1 045	65	61	53	47	45	160	125	--	--	
	3RT1 046	--	65	59	53	50	160	125	--	--	
	3RT1 054	65	65	65	65	65	160	125	--	--	
Operating range 25 ... 100 A											
3UF18 48-2EA00	3RT1 044	65	65	49	45	41.7	250	125	--	--	
	3RT1 045	80	61	53	47	45	250	160	--	--	
	3RT1 046	95	69	59	53	50	250	160	--	--	
	3RT1 054	100	93	82	75	69	250	160	125	125	
	3RT1 055	--	100	100	98	90	250	160	125	125	
	3RT1 056	--	--	--	100	100	250	160	125	125	

1) Voltage tolerance ±5 %.

2) Assignment and short-circuit protective devices acc. to IEC 60947-4-1:

Type of coordination 1:

Contactors or starters must not endanger persons or equipment in the event of a short-circuit. They do not have to be suitable for further operation without repair and the renewal of parts.

Type of coordination 2:

Contactors or starters must not endanger persons or equipment in the event of a short-circuit. These must be suitable for subsequent operation. There is a risk of contact welding.

3) Note the operational voltage.

Overload relays	Contactors	Rated operational current I_e AC-3 in A with 400 V and Class ...					Type of coordination ¹⁾				
		5 and 10	15	20	25	30	1		2		
							Fuse links in A ²⁾				
							LV HRC, Type 3NA		NH TYPE	British	
							DIAZED, Type 5SB		3ND	Standards	
							NEOZED Type 5SE			fuses	
							gL/gG		aM	BS88	
Operating range 32 ... 130 A											
3UF18 50-3AA00	3RT1 044	65	56	49	45	41.7	250	125	--	--	
	3RT1 045	80	61	53	47	45	250	160	--	--	
	3RT1 046	95	69	59	53	50	250	160	--	--	
	3RT1 054	115	93	82	75	69	315	224	160	160	
	3RT1 055	130	122	107	98	90	315	224	160	160	
	3RT1 056	--	130	130	120	111	315	224	160	160	
	3RT1 064	--	--	--	130	130	315	224	160	160	
Operating range 50 ... 200 A											
3UF18 52-3BA00	3RT1 054	115	93	82	75	69	355	224	160	200	
	3RT1 055	150	122	107	98	90	355	224	160	200	
	3RT1 056	185	150	131	120	111	355	224	160	200	
	3RT1 064	200	182	160	146	135	355	224	160	200	
	3RT1 065	--	200	188	172	159	355	224	160	200	
	3RT1 066	--	--	200	195	180	355	224	160	200	
	3RT1 075	--	--	--	200	200	355	224	160	200	
Operating range 63 ... 250 A											
3UF18 54-3CA00	3RT1 056	185	150	131	120	111	355	250	160	200	
	3RT1 064	225	182	160	146	135	400	250	250	355	
	3RT1 065	250	215	188	172	159	500	400	315	355	
	3RT1 066	--	243	213	195	180	500	400	315	355	
	3RT1 075	--	250	250	250	240	500	400	400	355	
	3RT1 076	--	--	--	--	250	500	400	400	355	
Operating range 100 ... 400 A											
3UF18 56-3DA00	3RT1 065	265	215	188	172	159	500	400	315	400	
	3RT1 066	300	243	213	195	180	500	400	315	400	
	3RT1 075	400	324	284	260	240	630	500	400	450	
	3RT1 076	--	400	355	325	300	630	500	500	450	
	3TF6 8	--	--	400	400	400	800	500	630	450	
Operating range 125 ... 500 A											
3UF18 57-3EA00	3RT1 066	300	243	213	195	180	500	400	315	400	
	3RT1 075	400	324	284	260	240	800	500	400	450	
	3RT1 076	500	405	355	325	300	800	500	500	450	
	3TF6 8	--	500	500	479	441	800	500	630	450	
	3TF6 9	--	--	--	500	500	800	500	630	450	
Operating range 160 ... 630 A											
3UF18 68-3FA00	3RT1 075	400	324	284	260	240	800	500	400	450	
	3RT1 076	500	405	355	325	300	800	500	500	450	
	3TF6 8	630	630	536	479	441	1000	500	630	450	
	3TF6 9	--	--	--	531	500	1000	500	630	450	
Operating range 200 ... 820 A											
3UF18 69-3GA00	3TF6 8	630	630	536	479	441	1000	500	630	450	
	3TF6 9	820	662	572	531	500	1000	500	630	450	

1) Assignment and short-circuit protective devices acc. to IEC 60947-4-1:

Type of coordination 1:

Contactors or starters must not endanger persons or equipment in the event of a short-circuit. They do not have to be suitable for further operation without repair and the renewal of parts.

Type of coordination 2:

Contactors or starters must not endanger persons or equipment in the event of a short-circuit. These must be suitable for subsequent operation. There is a risk of contact welding.

2) Note the operational voltage.

3UF18 current transformers for overload protection

Dimensional drawings

3UF18 43 current transformer

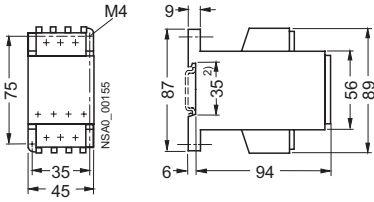

3UF18 45 current transformer

for stand-alone installation: for screw and snap-on mounting onto 35 mm standard mounting rails according to EN 50022

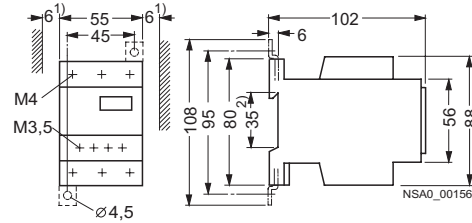

- 1) Clearance to grounded components.
- 2) Snap-on mounting onto standard mounting rails EN 50022-35 x 7.5 or EN 50022-35 x 15

3UF18 47 to 3UF18 52 current transformers

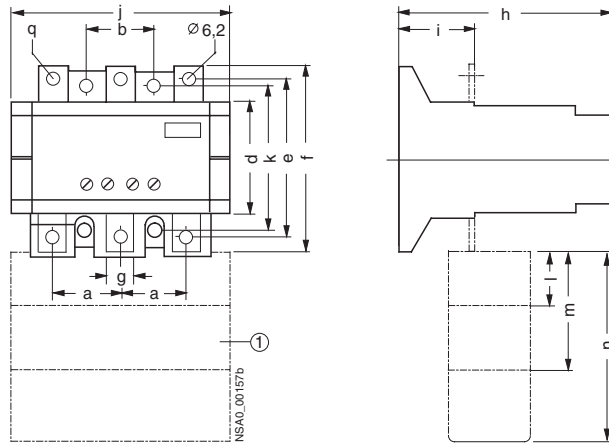

① Additional cover, can be shortened

Transformers	Contactors	a	b	d	e	f	g	h	i	j	k	l	m	n	q
3UF1 847	3RT1 044	26,5	25	82	111	122	10,5	90	46	90	105	35	62	89	Ø 6,2
3UF1 848	3RT1 045 3RT1 046	26,5	25	82	111	122	10,5	90	46	90	105	35	62	89	Ø 6,2
3UF1 850		37	37,5	71,5	99	114	15	110	41	120	95	33	67	98	Ø 6,6
3UF1 852		42	37,5	71,5	102	122	20	110	42	120	95	33	67	98	Ø 9

3UF1 854 to 3UF1 857 current transformers

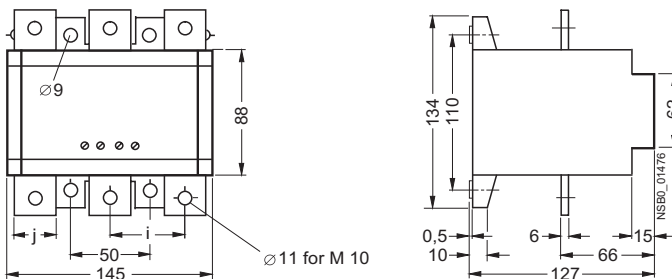

Transformers	i	j
3UF18 54	48	25
3UF18 56		
3UF18 57	52	30

3UF18 68-3FA00, 3UF18 68-3GA00 current transformers For 3TF68 contactors

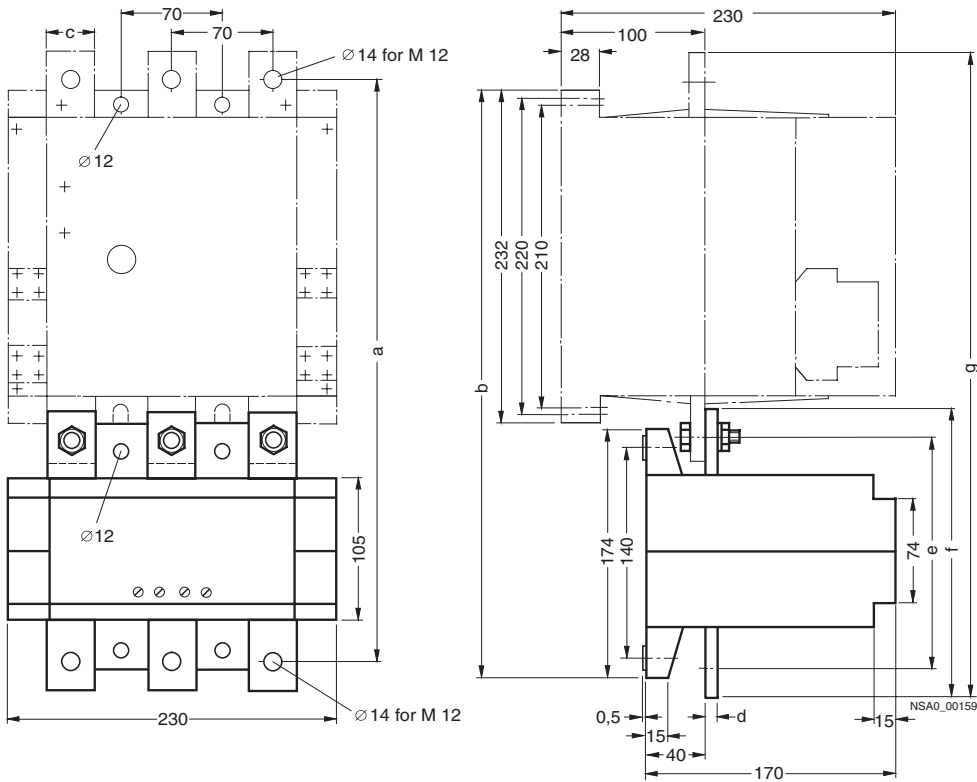

Transformers	Contactors	a	b	c	d	e	f	g
3UF18 68-3FA00	3TF68	390	398	30	5	145	175	420
3UF18 68-3GA00	3TF68	410	408	40	8	155	195	450

3UL22 summation current transformers

Overview

The 3UL22 summation current transformers sense fault currents in machines and plants. Together with the 3UL21 evaluation unit

or the SIMOCODE 3UF motor management and control device they enable residual-current and ground-fault monitoring.

Technical specifications

Summation current transformers

Type		3UL22 .1	3UL22 .2	3UL22 .3
Rated insulation voltage U_i	AC 50/60 Hz	690 V		1000 V
Rated fault current $I_{\Delta n}$				
• Without response delay	A	0.3 ... 1	0.3 ... 40	0.3 ... 40
• With response delay	A	1	1 ... 40	1 ... 40
Permissible ambient temperatures	°C	-20 ... +70		
Feed-through openings	mm	40	65	120
For Protodur cables can be fed through	max. mm ²	4 x 95	4 x 240	8 x 300

Dimensional drawings

3UL22 summation current transformers

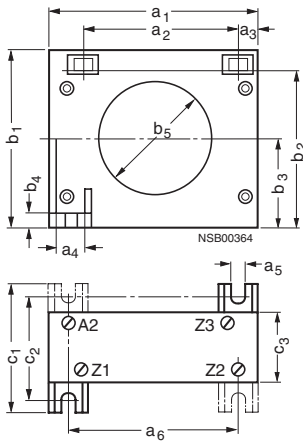

Type	a ₁	a ₂	a ₃	a ₄	a ₅	a ₆	b ₁	b ₂	b ₃	b ₄	b ₅	c ₁	c ₂	c ₃
3UL22 1-A	100	75	10	15	for M 4	80	85	72,5	42,5	7,5	40	65	50	40
3UL22 2-A	125	95	10	15	for M 4	100	110	97,5	55	7,5	65	70	60	45
3UL22 3-A	200	165	20	20	for M 4	170	200	100	100	10	120	85	70	55

Overview



- The compact, user-friendly, and low-cost solution for simple control tasks
- Compact, user-friendly, can be used universally without accessories
- "All in one": the display and operator panel are integrated
- 36 different functions can be linked at a press of a button or with PC software; up to 130 times in total
- Functions can be changed simply using buttons; no complicated rewiring

Catalog ST 70

Information on LOGO! can also be found in the catalog ST 70:

http://www.siemens.com/automation/simatic/ftp/st70/html_00/st70k1ad.pdf

Design

The LOGO! modular design is available in different variants for different supply voltages (12 V DC, 24 V DC, 24 V AC, 115/230 V DC, 115/230 V AC):

- Basic variants
- Low-cost pure variants without operator control and display panels

The LOGO! variants have the following distinguishing characteristics:

- R: Relay output
- C: Clock/time switch
- o: Without display

LOGO! is simple:

- Warning and switching off in one unit; no other tools are required
- Non-volatile storage of control program and setpoints (e.g. times) in integrated EEPROM

LOGO! is space-saving:

- e.g. LOGO! 230RC: 72 x 90 x 55 mm (W x H x D)
- Fitted mounting in the distribution box (same mounting dimensions as the ground-fault circuit interrupter)

LOGO! offers maximum flexibility and is universal:

- Expandability:
Depending on the application, additional expansion modules can be connected

LOGO! is communication-capable:

- Optional communication modules support interfacing to AS-Interface and instabus EIB networks

Function

LOGO! is simple:

- 36 functions:
Integrated basic functions (e.g. AND, OR) and special functions (e.g. timers, counters, latching relays, PI controllers) of the electronics
- Program generation simply by combining stored functions at the press of a key or PC software
- Easy-to-use and simple duplication of the control program with an optional program module

LOGO! offers maximum flexibility and is universal:

- Easy modification by reconnecting the functions at a press of a key; no need for time-consuming rewiring
- Optional operation from the PC:
For creating, simulating, online testing and archiving the control program on the PC, including documentation facility

LOGO! Modular basic variants

Overview



- The space-saving basic variants
- With interface for connection of expansion modules

Design

- Relay outputs with up to 10 A output signal (not LOGO! 24)
- Integrated front panel with background illumination (4x12 characters)
- Integrated operator control panel
- Integrated EEPROM for storing control program and setpoints
- Optional program module
- Integrated clock with automatic summertime/wintertime changeover (not LOGO! 24)
- 8 digital inputs, 4 digital outputs
- 2 inputs as analog inputs for 12/24 V DC variants (0 to 10 V); inputs can also be used as digital inputs
- 2 inputs for counting up to 2 kHz can be used (for DC variants only)
- Interface for connecting expansion modules, max. 24 digital inputs, 16 digital outputs, 8 analog inputs and 2 analog outputs can be addressed

Function

- Integrated basic and special functions:
 - Basic functions:
AND, OR, NOT, NAND, NOR, XOR, positive/negative flank evaluation
 - Special functions:
ON delay, latching ON delay, OFF delay, pulse relay, latching relay, counter (forwards/backwards), time switch, interval time-delay relay, operating hours meter, threshold switch, asynchronous pulse encoder, twelve-month time switch, easy-to-use switch function, random generator, staircase lighting function according to DIN 18015-2, edge-triggered interval time-delay relay, combined ON/OFF delay, analog comparator, analog threshold switch, analog delta threshold switch, analog watchdog, analog amplifier, text and variable display, shift register, softkey function, PI controller, ramp function, analog multiplexer
- 130 function blocks can be combined
- 24 flags (including start-up flag)
- Integrated retentivity
- Password protection

Optional function

- Additional know-how protection with the optional program module

Overview



- The cost-optimized basic variants
- With integrated interface for connection of expansion modules

Design

- Relay outputs with up to 10 A output signal
- Integrated EEPROM for storing control program and setpoints
- Optional program module
- Integrated clock with automatic summertime/wintertime changeover (not LOGO! 24o)
- 8 digital inputs, 4 digital outputs
- 2 inputs as analog inputs for 12/24 V DC variants (0 to 10 V); inputs can also be used as digital inputs
- 2 inputs for counting up to 2 kHz can be used (for DC variants only)
- Interface for connecting expansion modules, max. 24 digital inputs, 16 digital outputs, 8 analog inputs and 2 analog outputs can be addressed

Function

- Integrated basic and special functions:
 - Basic functions:
AND, OR, NOT, NAND, NOR, XOR, positive/negative flank evaluation
 - Special functions:
ON delay, latching ON delay, OFF delay, pulse relay, latching relay, counter (forwards/backwards), time switch, interval time-delay relay, operating hours meter, threshold switch, asynchronous pulse encoder, twelve-month time switch, easy-to-use switch function, random generator, staircase lighting function according to DIN 18015-2, edge-triggered interval time-delay relay, combined ON/OFF delay, analog comparator, analog threshold switch, analog delta threshold switch, analog watchdog, analog amplifier, shift register, softkey function, PI controller, ramp function, analog multiplexer
- 130 function blocks can be combined
- 24 flags (including start-up flag)
- Integrated retentivity
- Password protection

Optional function

- Additional know-how protection with the optional program module

LOGO! Software

Overview



- The user-friendly software for switchgear program generation on the PC
- Switchgear program generation for function diagrams (FBD) or contact diagrams (LAD)
- Additional testing, simulation, online testing and archiving of the switchgear programs
- Professional documentation with the help of various comment and print functions

Design

The connection between LOGO! and the PC is established with the help of the LOGO! PC cable (serial interface)

Minimum system requirements

Windows 98 SE, NT 4.0, ME, 2000 or XP

- Pentium PC
- 90 MB free on hard disk
- 64 MB RAM
- SVGA graphics card with minimum 800x600 resolution (256 colors)

Mac OS X

- PowerMac G3, G4, G4 Cube, iMac, PowerBook G3, G4 or iBook

Linux (tested with Caldera OpenLinux 2.4)

- Runs on all Linux releases on which Java 2 SDK Version 1.3.1 runs
- Please consult your Linux release for hardware requirements

Function

- Control program generation with the programming languages FBD and LAD (switchable). How to place the functions on the drawing board by means of "Drag and Drop" is almost self-explanatory
- Comprehensive documentation functions: Various print options permit professional documentation
- Program simulation (offline): For preliminary text of switching programs on the PC
- Program test (online): The current values of LOGO! are presented on screen
- Comprehensive, context-sensitive online help functions

The following functions are available:

- Basic functions (AND, OR, NOT, NAND, NOR, XOR, positive edge evaluation, negative edge evaluation)
- ON delay
- OFF delay
- Current impulse relay
- Latching
- Latching ON delay
- Operating hours meter
- Interval time-delay relay/pulse output mode
- Up/down counter
- Threshold switch
- Pulse encoder
- Twelve-month time switch
- Time switch
- ON/OFF delay
- Random generator
- Edge-triggered interval time-delay relay
- Analog threshold switch
- Analog comparator
- Analog delta threshold switch
- Analog watchdog
- Analog amplifier
- Staircase lighting switch
- Easy-to-use switch
- Message texts
- Shift register
- Softkey
- PI controller
- Ramp function
- Analog multiplexer

Function

3RP15/3RP20/7PV function table

Function	Function chart	3RP20 timing relay and 3RP19 01 label set	3RP15 timing relay and 3RP19 01 label set	7PV timing relay	
		3RP20 05-A	3RP20 25	3RP15 05-A 3RP19 01-0A	Identification letter 3RP15 1. 3RP15 25 3RP15 27 3RP15 3. 3RP15 40 3RP15 55 3RP15 7. 7PV33
1 CO contact					
ON-delay		■	■	■	A
OFF-delay with auxiliary voltage		■	■	■	B ¹⁾
OFF-delay without auxiliary voltage		■	■	■	
ON-delay and OFF-delay with auxiliary voltage ($t = t_{on} = t_{off}$)		■	■	■	C ¹⁾
Flashing, starting with interval (pulse/interval 1:1)		■	■	■	D
Clock-pulse, starting with interval (dead interval, pulse time, and time setting ranges each separately adjustable)		■	■	■	
Passing make contact		■	■	■	E
Passing break contact with auxiliary voltage		■	■	■	F ¹⁾
Pulse-forming with auxiliary voltage (pulse generation at the output does not depend on duration of energizing)		■	■	■	G ¹⁾
Additive ON-delay with auxiliary voltage		■	■	■	H ¹⁾
1 NO contact (semiconductor)					
ON-delay		■	■	■	

1) Note on function with start contact: A new control signal at terminal B, after the operating time has started, resets the operating time to zero. This does not apply to G, G● and H, H●, which are not retriggerable.

2) This function is indicated on the unit with the identification letter C.

3) For the flashing function, the start between interval D and pulse Di is selectable.

4) This function is indicated on the unit with the identification letter H.

5) This function is indicated on the unit with the identification letter B.

3RP, 7PV Timing Relays

General data

Function	Function chart	3RP20 timing relay and 3RP19 01 label set	3RP15 timing relay and 3RP19 01 label set	Identification letter
		3RP20 05-B	3RP20 25	3RP15 05-B 3RP19 01-0B
				3RP15 05-R 3RP19 01-0A
				3RP15 1. 3RP15 25 3RP15 27 3RP15 3. 3RP15 40 3RP15 55 3RP15 60 3RP15 7.
2 CO contacts				
ON-delay		■	■	A
ON-delay and instantaneous contact		■	■	A●
OFF-delay with auxiliary voltage		■	■	B ¹⁾
OFF-delay with auxiliary voltage and instantaneous contact		■	■	B● ¹⁾
OFF-delay without auxiliary voltage				
ON-delay and OFF-delay with auxiliary voltage ($t_{on} = t_{off}$)		■	■	C ¹⁾
ON-delay and OFF-delay with auxiliary voltage and instantaneous contact ($t_{on} = t_{off}$)		■	■	C● ¹⁾
Flashing, starting with interval (pulse/interval 1:1)		■	■	D
Flashing, starting with interval (pulse/interval 1:1) and instantaneous contact		■	■	D●
Passing make contact		■	■	E
Passing make contact and instantaneous contact		■	■	E●

1) Note on function with start contact: A new control signal at terminal B, after the operating time has started, resets the operating time to zero. This does not apply to G, G● and H, H●, which are not retriggerable.

Function	Function chart	3RP20 timing relay and 3RP19 01 label set	3RP20 05-B	3RP20 25	3RP15 05-B	3RP19 01-0B	3RP15 05-R	3RP19 01-0A	Identification letter	3RP15 1.	3RP15 25	3RP15 27	3RP15 3.	3RP15 40	3RP15 55	3RP15 60	3RP15 7.	
2 CO contacts																		
Passing break contact with auxiliary voltage		■			■		■		F ¹⁾									
Passing break contact with auxiliary voltage and instantaneous contact		■			■				F ¹⁾									
Pulse-forming with auxiliary voltage (pulse generation at the output does not depend on duration of energizing)		■			■		■		G ¹⁾									
Pulse-forming with auxiliary voltage and instantaneous contact (pulse generation at the output does not depend on duration of energizing)		■			■				G ¹⁾									
Additive ON-delay with auxiliary voltage							■		H ¹⁾									
Additive ON-delay with auxiliary voltage and instantaneous contact		■			■				H ¹⁾									
Wye-delta function		■			■				YΔ									
2 NO contacts																		
Wye-delta function YΔ																		■
3 NO contacts																		
Wye-delta function with overtravel function ²⁾ (idling)																		■

1) Note on function with start contact: A new control signal at terminal B, after the operating time has started, resets the operating time to zero. This does not apply to G, G● and H, H●, which are not retriggerable.



2) For function diagrams showing the various possibilities of operation of the 3RP15 60-1S.30 (see Page 7/48).

3RP, 7PV Timing Relays

General data

3RP15 function table

Possibilities of operation of the 3RP15 60-1S.30 timing relay

-  Timing relay energized
-  Contact closed
-  Contact open

Operation 1

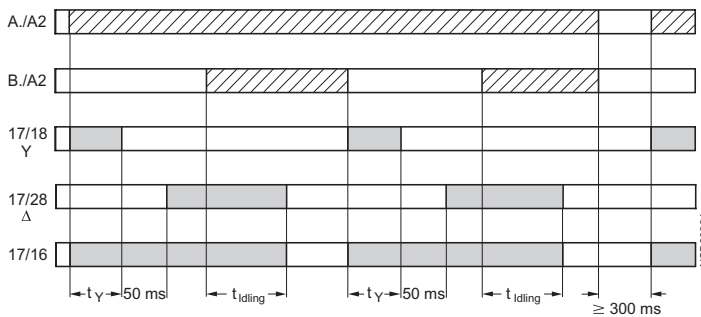

Operation 2

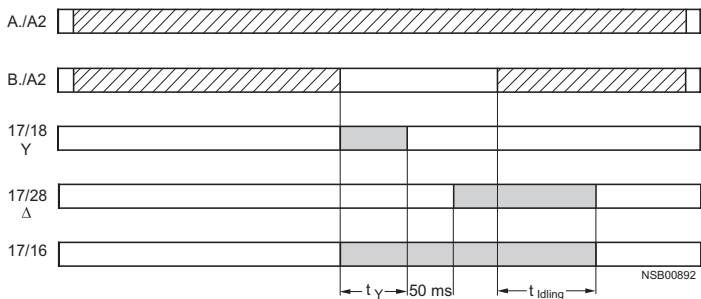

Operation 3

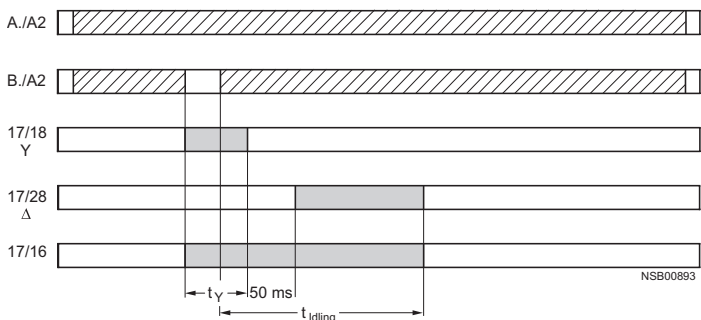

Operation 4

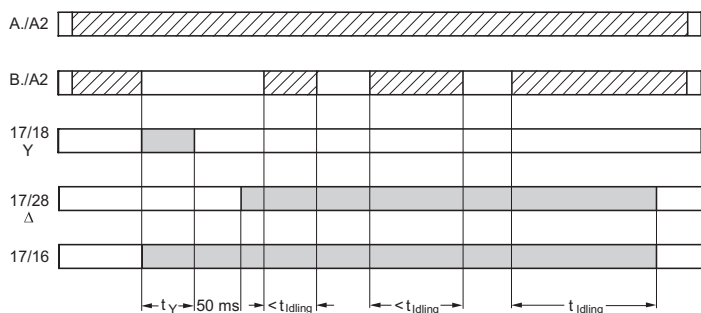

- t_y = star time 1 to 20 s
- t_{idling} = idling time (overtravel time) 30 to 600 s

Operation 1:

Start contact B./A2 is opened when supply voltage A./A2 is applied.

The supply voltage is applied to A./A2 and there is no control signal on B./A2. This starts the $\Upsilon\Delta$ timing. The idling time (overtravel time) is started by applying a control signal to B./A2. When the set time t_{idling} (30 to 600 s) has elapsed, the output relays (17/16 and 17/28) are reset. If the control signal on B./A2 is switched off (minimum OFF period 270 ms), a new timing is started.

Comments:

Observe response time (dead time) of 400 ms on energizing supply voltage until contacts 17/18 and 17/16 close.

Operation 2:

Start contact B./A2 is closed when supply voltage A./A2 is applied.

If the control signal B./A2 is already present when the supply voltage A./A2 is applied, **no** timing is started. The timing is only started when the control signal B./A2 is switched off.

Operation 3:

Start contact B./A2 closes while star time is running.

If the control signal B./A2 is applied again during the star time, the idling time starts and the timing is terminated normally.

Operation 4:

Start contact B./A2 opens while delta time is running and is applied again.

If the control signal on B./A2 is applied and switched off again during the delta time, although the idling time has not yet elapsed, the idling time (overtravel time) is reset to zero. If the control signal is re-applied to B./A2, the idling time is restarted.

Application example based on standard operation (operation 1)

For example, use of 3RP15 60 for compressor control

Frequent starting of compressors strains the network, the machine, and the increased costs for the operator. The new timing relay prevents frequent starting at times when there is high demand for compressed air. A special control circuit prevents the compressor from being switched off immediately when the required air pressure in the tank has been reached. Instead, the valve in the intake tube is closed and the compressor runs in "Idling" mode for a specific time which can be set from 30 to 600 s.

If the pressure falls within this time, the motor does not have to be restarted again, but can return to nominal load operation from no-load operation.

If the pressure does not fall within this idling time, the motor is switched off.

the pressure switch controls the timing via B./A2.

The supply voltage is applied to A./A2 and the start contact B./A2 is open, i.e. there is no control signal on B./A2 when the supply voltage is applied. The pressure switch signals "too little pressure in system" and starts the timing by way of terminal B./A2. The compressor is started, enters $\Upsilon\Delta$ operation, and fills the pressure tank.

When the pressure switch signals "sufficient pressure", the control signal B./A2 is applied, the idling time (overtravel time) is started, and the compressor enters no-load operation for the set period of time between 30 to 600 s. The compressor is then switched off. The compressor is only restarted if the pressure switch responds again (low pressure).

The following applies to all operations:
The pressure switch controls the timing via B./A2.

Overview

Standards

The timing relays comply with:

- EN 60721-3-3 "Environmental conditions"
- EN 61812-1/DIN VDE 0435 Part 2021 "Solid-state relays, timing relays"
- EN 61000-6-2 and EN 61000-6-4 "Electromagnetic compatibility"
- EN 60947-5-1; (VDE 0660 Part 200) "Low-voltage controlgear, switchgear and systems – Electromechanical controlgear"

3RP15 timing relays, width 22.5 mm

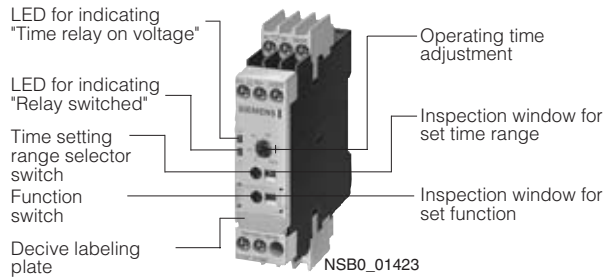

Accessories

Push-in lugs for screw mounting



Sealable cap



Label set for marking the multifunction relay



Function

- Changes to the time setting ranges and the functions must be carried out in the de-energized state
- Start input B1 or B3 must only be triggered when the supply voltage is applied
- The same potential must be applied to A1 and B1 or A3 and B3. With two-voltage version, only one voltage range must be connected
- The activation of loads parallel to the start input is not permissible when using AC (see diagrams)
- Surge suppression is integrated in the timing relay. This prevents the generation of voltage peaks on the supply voltage when the relay is switched on and off. No additional damping measures are necessary
- 3RP15 05-.R must not be operated next to heat sources > 60 °C

Parallel load on start input

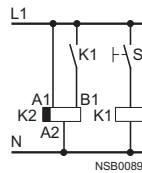
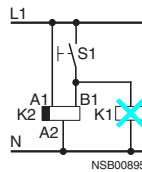

3RP, 7PV Timing Relays

3RP15 timing relays in industrial enclosure, 22.5 mm

Technical specifications

Type		3RP15 05 3RP15 31 3RP15 32 3RP15 33	3RP15 11 3RP15 12 3RP15 13 3RP15 25 3RP15 55	3RP15 40	3RP15 60	3RP15 74 3RP15 76	3RP15 27
Rated insulation voltage Pollution degree 3 Overvoltage category III	V AC	300; 500 for 3RP15 05-1BT10					
Operating range at excitation ¹⁾		0.85 ... 1.1 x U _s with AC; 0.8 ... 1.25 x U _s with DC; 0.95 ... 1.05 times rated frequency					
Rated power • Power consumption at 230 V AC, 50 Hz	W VA	2 6		2 ²⁾	6		1 1
Rated operational current I_e • AC-14, DC-13 • AC-15 at 230V, 50 Hz • DC-13 at - 24 V - 48 V - 60 V - 110 V - 230 V	A	-- 3 ³⁾ 1 0.45 0.35 0.2 0.1					0.01 ... 0.6 -- -- -- -- --
DIAZED fuse ⁴⁾ gL/gG operational class	A	4					--
Switching frequency • When loaded with I _e 230 V AC • When loaded with 3RT10 16 contactor, 230 V AC	1/h	2500 5000					5000
Recovery time	ms	150			300	150	50
Minimum ON period	ms	35 ⁵⁾	--	200 ⁶⁾	--		
Residual current with non-conducting output	mA	--					5
Voltage drop with conducting output	VA	--					3.5
Short-time loading capacity		--					10 (to 10 ms)
Setting accuracy with reference to scale value		Typical ±5 %					
Repeat accuracy		≤ ±1%					
Mechanical endurance	Operating cycles	30 x 10 ⁶					100 x 10 ⁶
Permissible ambient temperature	During operation	°C -25 ... +60					
	During storage	°C -40 ... +85					
Degree of protection acc. to EN 60529		IP40 cover, IP20 terminals					
Conductor cross-sections • Screw-type connection (to connect 1 or 2 conductors); for standard screwdriver (size 2 and Pozidriv 2) • Spring-loaded terminal (to connect 1 or 2 conductors; for 22.5 mm timing relay use screwdriver with 3 mm blade or 8WA2 807 opening tool)	Solid Finely stranded with end sleeve AWG conductors, solid or stranded Terminal screw Tightening torque Solid Finely stranded • With end sleeve • Without end sleeve AWG conductors, solid or stranded	mm ² mm ² AWG Nm mm ² mm ² mm ² AWG	1 x (0.5 ... 4) 2 x (0.5 ... 2.5) 1 x (0.5 ... 2.5) 2 x (0.5 ... 1.5) 2 x (20 ... 14) M 3.5 0.8 ... 1.2 2 x (0.25 ... 1.5) 2 x (0.25 ... 1) 2 x (0.25 ... 1.5) 2 x (24 ... 16)				
Permissible		Any					
Shock resistance acc. to IEC 60068 for half-sine shock type	g/ms	15/11					
Vibration resistance acc. to IEC 60068-2-6	Hz/mm	10 ... 55/0.35					
Electromagnetic compatibility (EMC) Tests acc. to basic specification		EN 61000-6-2/EN 61000-6-4					

- 1) If nothing else is stated.
- 2) Maximum inrush current 1A/100 ms.
- 3) For 3RP15 05-.R: NC contact → I_e = 1 A.
- 4) I_k ≥ 1 kA weld-free acc. to IEC 60947-5-1
- 5) Minimum ON period with 3RP15 05-.BW30, 150 ms, until instantaneous contact has switched.
- 6) For correct operation, observe minimum ON period.

Dimensional drawings

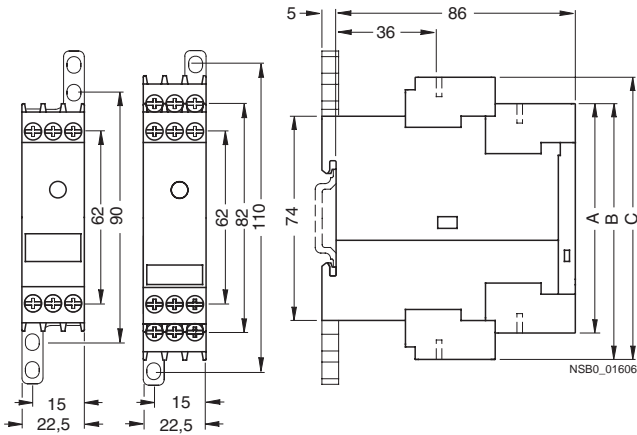

	A	B	C
Type	3RP15 1 3RP15 25-A 3RP15 27 3RP15 10-A 3RP15 55 3RP15 7		3RP15 05 3RP15 25-B 3RP15 3 3RP15 40-B 3RP15 60
Removable terminal			
Spring-loaded terminal	84	94	103
Screw-type terminal	83	92	102

Schematics

3RP15 internal schematics (terminal designation to DIN 46199, Part 5)

3RP15 05-A
3RP15 1.
3RP15 25-A

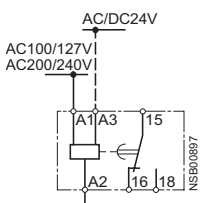

ON-delay

3RP15 05-A
3RP15 3.-A

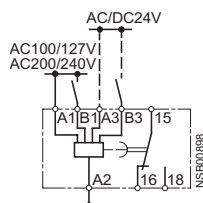

OFF-delay with auxiliary voltage

3RP15 05-A

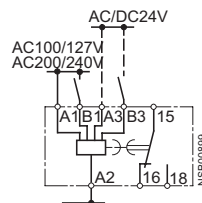

ON-delay and OFF-delay with auxiliary voltage

3RP15 05-A

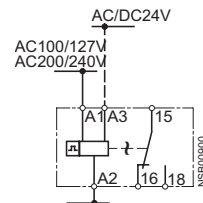

Flashing

3RP15 05-A

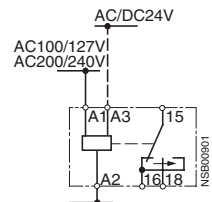

Passing make contact

3RP15 05-A

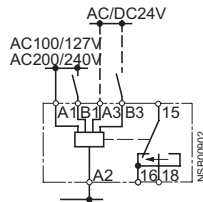

Passing break contact with auxiliary voltage

3RP15 05-A

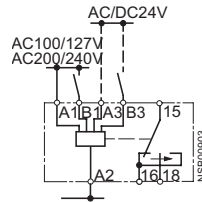

Pulse-forming with auxiliary voltage

3RP15 05-A

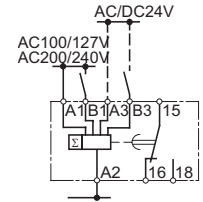

Additive ON-delay with auxiliary voltage



3RP, 7PV Timing Relays

3RP15 timing relays in industrial enclosure, 22.5 mm

3RP15 27
 $U = 24 \dots 66 \text{ V AC/DC}$
 $90 \dots 240 \text{ V AC/DC}$

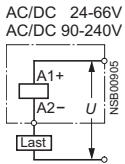

ON-delay,
two-wire design

3RP15 40-A

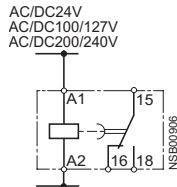

OFF-delay
without auxiliary voltage

3RP15 55

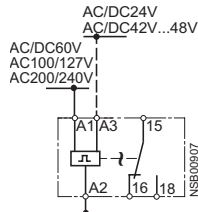

Clock-pulse relay

3RP15 05-AW30

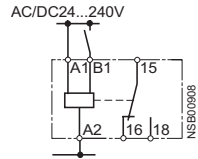

Multi-function relay
(same functions as 3RP15 05-1A)

3RP15 05-B, 3RP15 25-1B

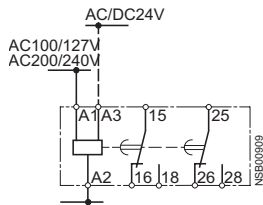

ON-delay, 3RP15 25-1B
also for 42...48/60 V AC/DC
(see page 8/13 3RP15 25-1BR30)

3RP15 05-B

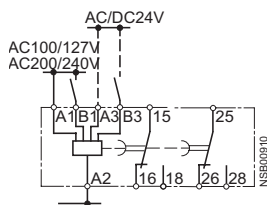

OFF-delay with auxiliary voltage

3RP15 05-B

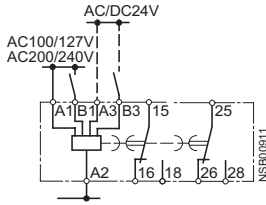

ON-delay and OFF-delay
with auxiliary voltage

3RP15 05-B

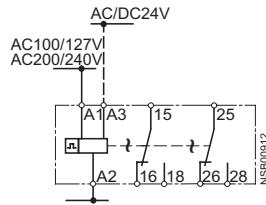

Flashing

3RP15 05-B

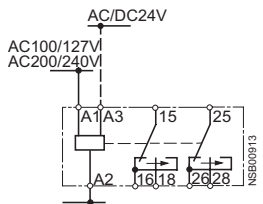

Passing make contact

3RP15 05-B

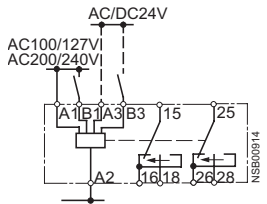

Passing break contact with
auxiliary voltage

3RP15 05-B

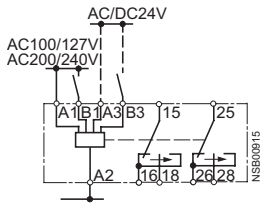

Pulse-forming with auxiliary voltage

3RP15 05-B

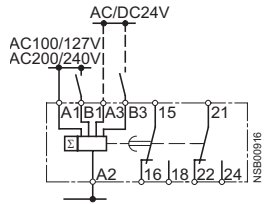

Additive ON-delay with auxiliary
voltage and instantaneous contact

3RP15 05-B

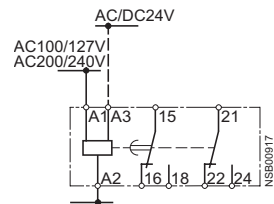

ON-delay and instantaneous
contact

3RP15 05-B

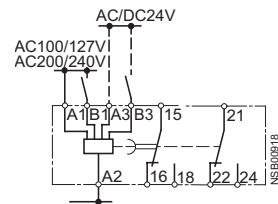

OFF-delay with auxiliary voltage
and instantaneous contact

3RP15 05-B

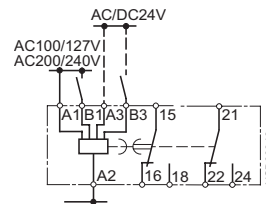

ON-delay and OFF-delay with
auxiliary voltage and instantaneous
contact

3RP15 05-B

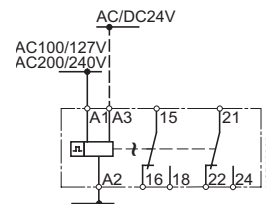

Flashing and instantaneous contact

3RP15 05-B

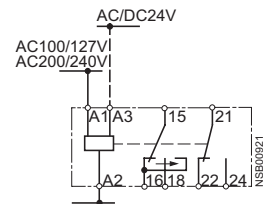

Passing make contact
and instantaneous contact

3RP15 05-B

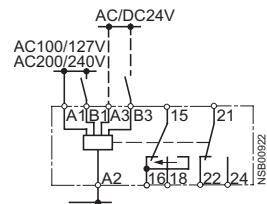

Passing break contact with
auxiliary voltage and instantaneous
contact

3RP15 05-B

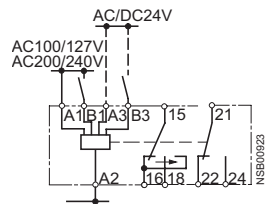

Pulse-forming with auxiliary voltage
and instantaneous contact

3RP15 05-B

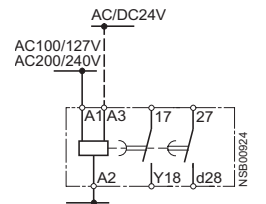

Wye-delta function

3RP, 7PV Timing Relays

3RP15 timing relays in industrial enclosure, 22.5 mm

3RP15 05-.BW30/-1BT20/-RW30

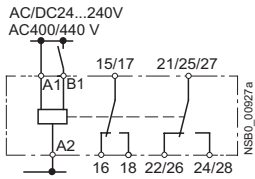

Multi-function relay
(for functions see function table)

3RP15 25-.BR30

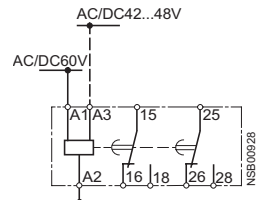

ON-delay

3RP15 25-.BW30

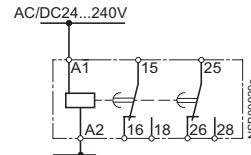

ON-delay

3RP15 40-B

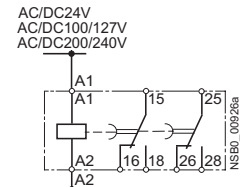

OFF-delay without
auxiliary voltage

3RP15 60-.S

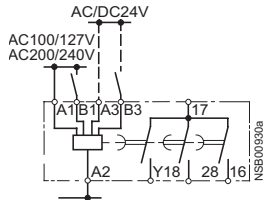

Wye-delta timing relay with
overtravel function (idling)

3RP15 7-.M20

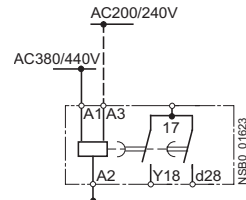

Wye-delta timing relay

3RP15 74, 3RP15 76

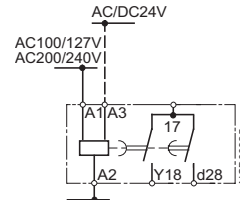

Wye-delta timing relay

Position of the connection terminals

3RP15 05-.A



3RP15 05-.AA40



3RP15 05-.AW



3RP15 05-.BP/-BQ



3RP15 05-.BW

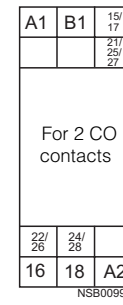

3RP15 05-1BT



3RP15 05-.RW



3RP15 1.

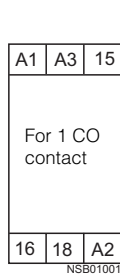

3RP15 25-1A. or -1B. 1)

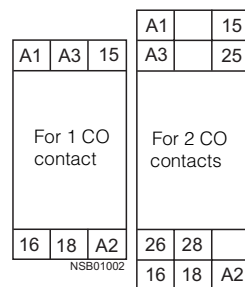

3RP15 27



3RP15 3.

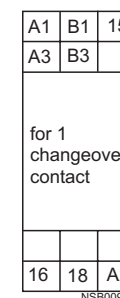

3RP15 40

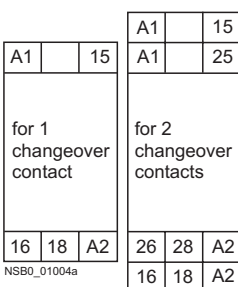

3RP15 55

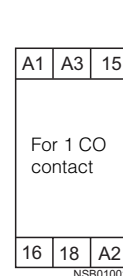

3RP15 60

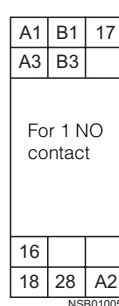

3RP15 7.

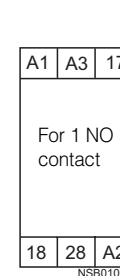

Note: All the diagrams show the view onto the connection terminals.

1) Depending on the version.



Overview

Standards

The timing relays comply with:

- EN 60721-3-3 "Environmental conditions"
- EN 61812-1/DIN VDE 0435 Part 2021 "Solid-state relays, timing relays"
- EN 61000-6-2 and EN 61000-6-4 "Electromagnetic compatibility"
- EN 60947-5-1; (VDE 0660 Part 200) "Low-voltage controlgear, switchgear and systems – Electromechanical controlgear"
- EN 61140 "Safe electrical isolation"

3RP20 timing relay, width 45 mm

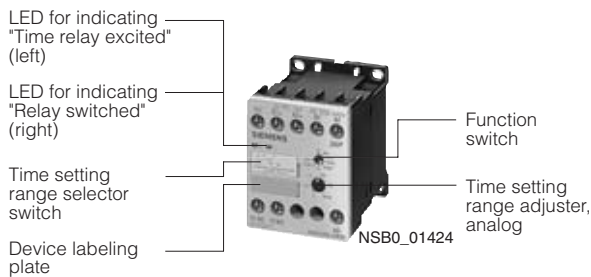

Accessories

Label set for marking the multifunction relay

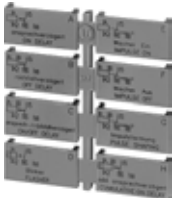

Function

- Changes to the time setting ranges and the functions must be carried out in the de-energized state
- Start input B1 or B3 must only be triggered when the supply voltage is applied
- The same potential must be applied to A1 and B1 or A3 and B3. With two-voltage version, only one voltage range must be connected
- The activation of loads parallel to the start input is not permissible when using AC (see diagrams)
- Surge suppression is integrated in the timing relay. This prevents the generation of voltage peaks on the supply voltage when the relay is switched on and off. No additional damping measures are necessary

Timing relay with multifunction

The functions can be adjusted by means of rotary switches. Indicator labels can be used to adjust different functions of the 3RP20 05 timing relay clearly and unmistakably.

The corresponding labels can be ordered as an accessory. The same potential must be applied to terminals A. and B..

3RP20 05 with one changeover contact

Corresponds to the functions of 3RP15 05-.A.

3RP20 05 with two changeover contacts

Corresponds to the functions of 3RP15 05-.B.

Parallel load on start input

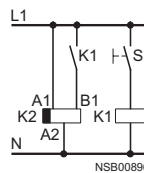
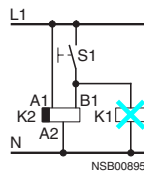

3RP, 7PV Timing Relays

3RP20 timing relays, 45 mm

Technical specifications

Type		3RP20 05	3RP20 25
Rated insulation voltage Pollution degree 3 Overvoltage category III	V AC	300	
Operating range at excitation¹⁾		0.85 ... 1.1 x U_s with AC; 0.8 ... 1.25 x U_s with DC; 0.95 ... 1.05 times rated frequency	
Rated power • Power consumption at 230 V AC, 50 Hz	W VA	1 4	
Rated operational current I_e • AC-15 at 230 V, 50 Hz • DC-13 at - 24 V - 48 V - 60 V - 110 V - 230 V	A	3 1 0.45 0.35 0.2 0.1	
DIAZED fuse²⁾ gL/gG operational class	A	4	
Switching frequency • When loaded with I_e 230 V AC • When loaded with 3RT10 16 contactor, 230 V AC	1/h 1/h	2500 5000	
Recovery time	ms	150	
Minimum ON period	ms	35	
Setting accuracy with reference to scale value		Typical $\pm 5\%$	
Repeat accuracy		$\leq \pm 1\%$	
Mechanical endurance	Operating cycles	30×10^6	
Permissible ambient temperature	During operation During storage	°C °C	-25 ... +60 -40 ... +85
Degree of protection acc. to EN 60529		IP40 cover, IP20 terminals	
Conductor cross-sections • Screw-type connection (to connect 1 or 2 conductors); for standard screwdriver (size 2 and Pozidriv 2) • Spring-loaded terminal (to connect 1 or 2 conductors; for 22.5 mm timing relay use screwdriver with 3 mm blade or 8WA2 807 opening tool)	Solid Finely stranded with end sleeve AWG conductors, solid or stranded Terminal screw Tightening torque Solid Finely stranded • With end sleeve • Without end sleeve AWG conductors, solid or stranded	mm ² mm ² AWG Nm mm ² mm ² mm ² AWG	2 x (0.5 ... 1.5) 2 x (0.75 ... 2.5) 2 x (0.5 ... 1.5) 2 x (0.75 ... 2.5) 2 x (18 ... 14) M3 0.8 ... 1.2 2 x (0.25 ... 2.5) 2 x (0.25 ... 1.5) 2 x (0.25 ... 2.5) 2 x (24 ... 14)
Mounting position (permissible)		Any	
Shock resistance acc. to IEC 60068 for half-sine shock type	g/ms	15/11	
Vibration resistance acc. to IEC 60068-2-6	Hz/mm	10 ... 55/0.35	
Electromagnetic compatibility (EMC) Tests acc. to basic specification		EN 61000-6-2/EN 61000-6-4	

1) If nothing else is stated.

2) $I_k \geq 1$ kA, weld-free acc. to IEC 60947-5-1.

Dimensional drawings

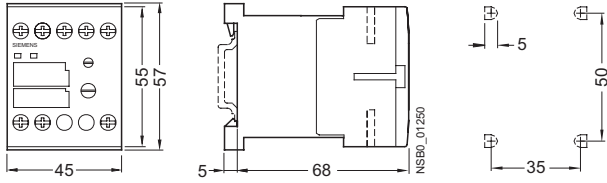

Schematics

3RP20 internal schematics (terminal designation to DIN 46199, Part 5)

3RP20 05
3RP20 25

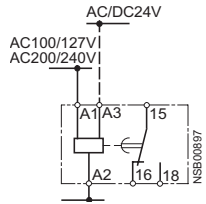

ON-delay

3RP20 05

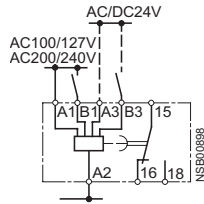

OFF-delay
with auxiliary voltage

3RP20 05

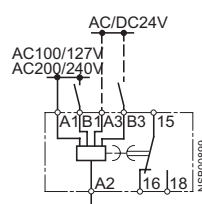

ON-delay and OFF-delay
with auxiliary voltage

3RP20 05

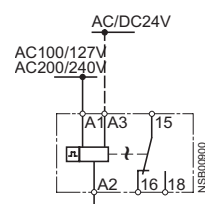

Flashing

3RP20 05

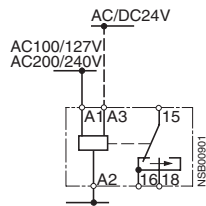

Passing make contact

3RP20 05

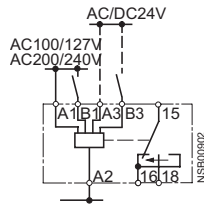

Passing break contact
with auxiliary voltage

3RP20 05

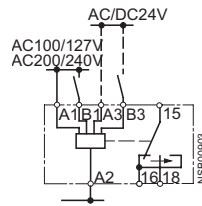

Pulse-forming
with auxiliary voltage

Position of the connection terminals

3RP20 05-.A

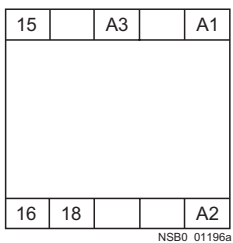

3RP20 25-.A

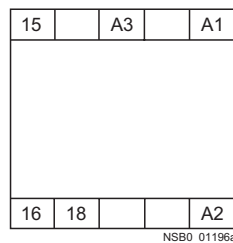

3RP20 05-.BW30

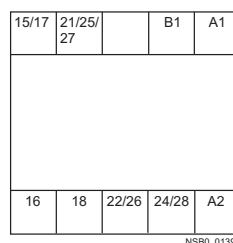

Note: All the diagrams show the view onto the connection terminals.

3RP, 7PV Timing Relays

7PV timing relays for panel mounting

Technical specifications

Type		7PV33 48
Rated insulation voltage Overvoltage category C to DIN VDE 0110	V AC	250
Operating range of excitation		+10 ... -15 %
Rated power • Power consumption at 230 V AC, 50 Hz	W VA	1 11
Rated operational currents I_e AC-1 at AC 230 V, 50 Hz	A	8
Switching frequency • When loaded with I_e 230 V AC • When loaded with 3RT16 contactor, AC 230 V	1/h 1/h	600 --
Recovery time	ms	50
Minimum ON period	ms	50
Setting accuracy • With reference to upper limit of scale		± 0.03 % ± 10 ms
Repeat accuracy		± 0.03 % ± 10 ms
Mechanical endurance	Operating cycles	5×10^6
Permissible ambient temperature	During operation During storage	$^{\circ}\text{C}$ -10 ... +60 $^{\circ}\text{C}$ -30 ... +70
Degree of protection acc. to EN 60529		IP65
Permissible mounting positions		Any

Dimensional drawings

7PV33

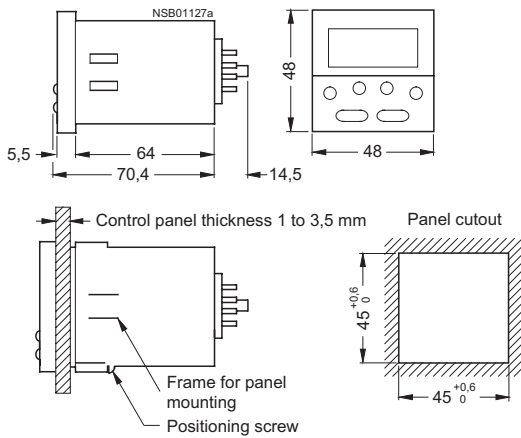

LZX:MT78750 socket accessory, for 7PV33

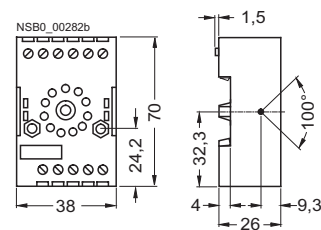

7PX9921 socket accessory with rear connection

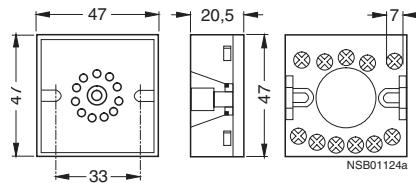

7PV timing relays for panel mounting

Schematics

7PV internal schematics (terminal designation according to DIN 46199, Part 5)

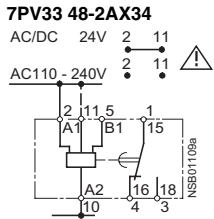

ON-delay (A)

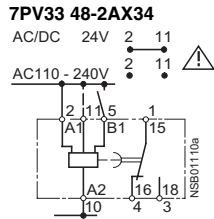

OFF-delay with auxiliary voltage (C)

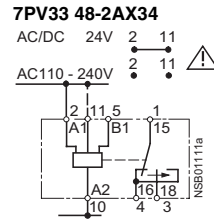

Passing make contact (H)

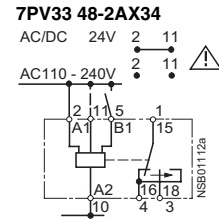

Pulse-forming with auxiliary voltage (B)

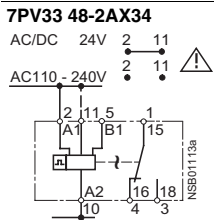

Flashing, starting with interval (D)

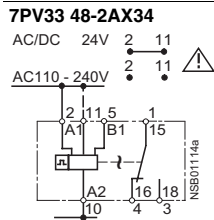

Flashing, starting with pulse (Di)

⚠ Important!

The terminal designations for 7PV are different from the designations for the 3RP1 terminals.

Position of the connection terminals

LZX: MT78750 socket
for 7PV33 timing relays

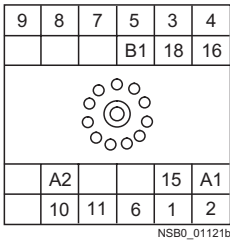

7PX9 921 socket
for 7PV33 timing relays

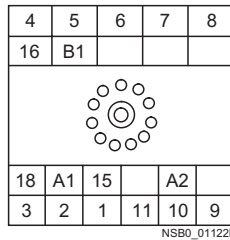

3RP, 7PV Timing Relays

3RT19 timing relays for mounting to contactors

Technical specifications

According to IEC 61 812-1/DIN VDE 0435 Part 2021

Type		3RT19 16-2C 3RT19 16-2D 3RT19 26-2C 3RT19 26-2D	3RT19 16-2E 3RT19 16-2F 3RT19 16-2L 3RT19 26-2E 3RT19 26-2F 3RT19 26-2G
Rated insulation voltage Pollution degree 3 Overvoltage category III to DIN VDE 0110	V AC	300	
Operating range of excitation		0.8...1.1 x U_N , 0.95 ... 1.05 times rated frequency	0.85...1.1 x U_N , 0.95 ... 1.05 times rated frequency
Rated power • Power consumption at 230 V AC, 50 Hz	W VA	1 1	2 (1 W for 3RT1916-2L) 4
Rated operational currents I_e • AC-14 and DC-13	A	0.3 for 3RT1916 0.5 for 3RT1926	--
• AC-15 at 230 V AC, 50 Hz	A	--	3
• DC-13 at 24 V	A	--	1
• DC-13 at 110 V	A	--	0.2
• DC-13 at 230 V	A	--	0.1
DIAZED fuse gL/gG operational class	A	--	4
Switching frequency • When loaded with I_e 230 V AC • When loaded with 3RT1016 contactor, 230 V AC	1/h 1/h	2500 2500	2500 5000
Recovery time	ms	50	150
Minimum ON period	ms	35	200 (OFF-delay, without auxiliary voltage) 3RT1916-2L: 35 (OFF-delay, with auxiliary voltage)
Residual current (two-wire)	mA	≤ 5	--
Voltage drop with conducting output	VA	≤ 3.5	--
Short-time loading capacity	A	10 (to 10 ms)	--
Setting accuracy with reference to upper limit of scale		≤ ±15 %	
Repeat accuracy		≤ ±1%	
Mechanical endurance	Operating cycles	100 x 10 ⁶	10 x 10 ⁶
Permissible ambient temperature	During operation During storage	°C °C	-25 ... +60 -40 ... +85
Degree of protection acc. to EN 60529		IP 40 cover IP 20 terminals	
Connection of conductors	Solid Finely stranded with end sleeve Solid or stranded	mm ² mm ² AWG	2 x (0.5 ... 1.5), 2 x (0.75 ... 4) 2 x (0.5 ... 2.5) 2 x (18 ... 14)
Terminal screw		M3	
Tightening torque		Nm	0.8 ... 1.2
Permissible mounting position			Any
Shock resistance Half sine acc. to IEC 60068-2-27		g/ms	15/11
Vibration resistance acc. to IEC 60068-2-6		Hz/mm	10 ... 55 / 0.35
EMC tests acc. to basic specification			IEC 61000-6-2/IEC 61000-6-4
Overvoltage protection	Varistor		Integrated into timing relay Integrated into 3RT19 16

3RT19 timing relays for mounting to contactors

Dimensional drawings

3RT19 16-2E, -2F, -2G, -2L
solid-state time-delay auxiliary switch blocks
 for size S00 contactors and contactor relays

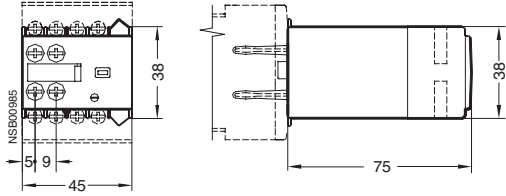

3RT19 26-2E, -2F, -2G
 for size S0 to S3 contactors and contactor relays

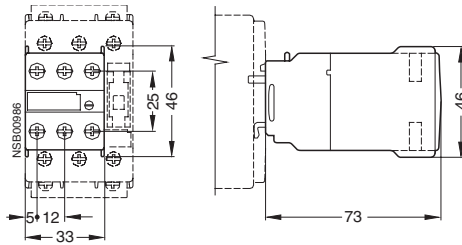

3RT19 16-2C solid-state time-delay blocks, ON-delay
 for mounting onto the front of size S00 contactors

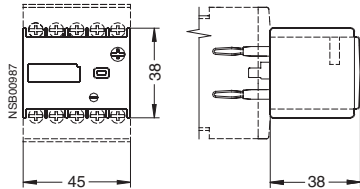

3RT19 26-2C
 mountable on top or bottom of the contactors for size S0 to S3

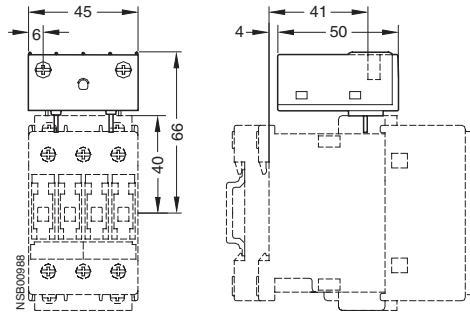

3RT19 16-2D solid-state time-delay blocks, OFF-delay
 for mounting onto the front of size S00 contactors

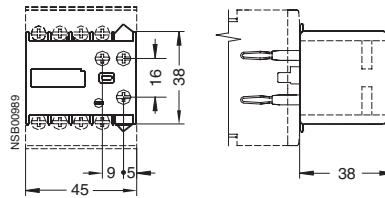

3RT19 26-2D
 mountable on top or bottom of the contactors for size S0 to S3

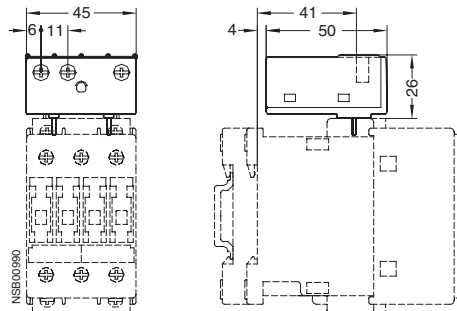

3RP, 7PV Timing Relays

3RT19 timing relays for mounting to contactors

Schematics

3RT19 circuit diagrams

Control circuits (example circuits)
with delayed 3RT19 .6-2G wye-delta auxiliary switch block

For pushbutton operation

Size S00

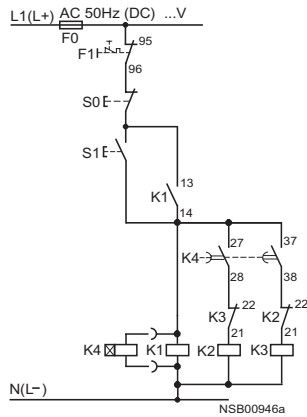

Sizes S0 to S3

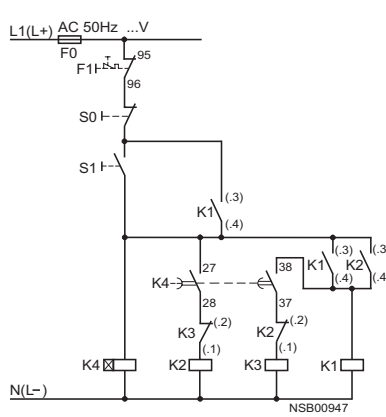

For maintained-contact operation

Size S00

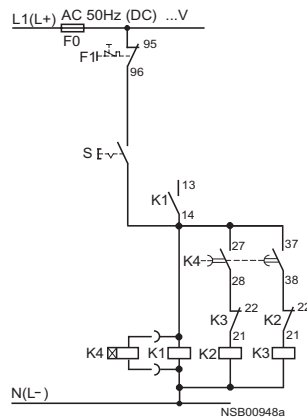

Sizes S0 to S3

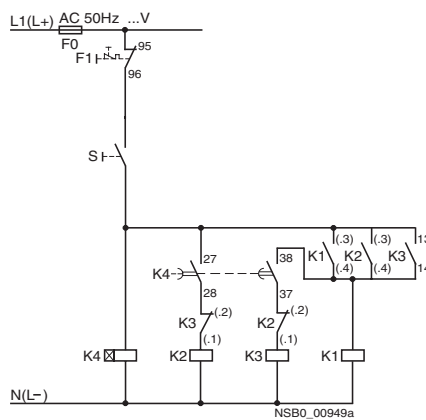

Legend:

- S0 "OFF" button
- S1 "ON" button
- S Maintained-contact switch
- K1 Line contactor
- K2 Star contactor
- K3 Delta contactor
- K4 Timer or timing relay
- F0 Fuse
- F1 Overload relay

The 27/28 contact element for the solid-state time-delay auxiliary switch block with wye-delta function is only closed on the delta level; the contact element is open in the delta stage as well as in the de-energized state.

Solid-state timing relay blocks

for size S00 to S3 3RT10 contactors and 3RH11 contactor relays

3RT19 16-2C...

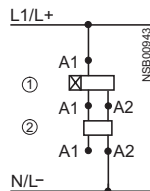

ON-delay

3RT19 26-2C...

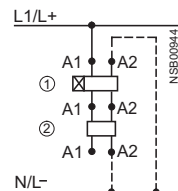

ON-delay

3RT19 16-2D.../3RT19 26-2D...

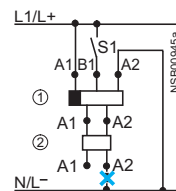

OFF-delay
(with auxiliary voltage)

- ① Timing relay block
- ② Contactor
- Can be connected
- ✘ **Do not connect!**

Monitoring Relays

3UG Monitoring Relays for Electrical and Additional Measurements

Line monitoring

Overview



Solid-state line monitoring relays provide maximum protection for mobile machines and plants or for unstable networks. Network and voltage faults can be detected early and rectified before far greater damage ensues.

Depending on the version, the relays monitor phase sequence, phase failure with and without N conductor monitoring, phase unbalance, undervoltage or overvoltage. With the 3UG46 17 or 3UG46 18 relay, a wrong direction of rotation can also be corrected automatically.

Function

3UG45 11 monitoring relays

The 3UG45 11 phase sequenced relay monitors the phase sequence in a three-phase network. No adjustments are required for operation. The device has an internal power supply and works using the closed-circuit principle. If the phase sequence at the terminals L1-L2-L3 is correct, the output relay picks up after the delay time has elapsed and the LED is lit. If the phase sequence is wrong, the output relays remain in their rest position.

Note:
When one phase fails, connected loads (motor windings, lamps, transformers, coils, etc.) create a feedback voltage at the terminal of the failed phase due to the network coupling. Because the 3UG45 11 relays are not resistant to voltage feedback, such a phase failure is not detected. Should this be required, then the 3UG45 12 monitoring relay must be used.

Correct phase sequence

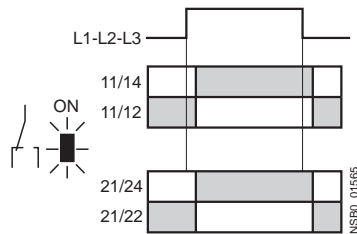

Wrong phase sequence

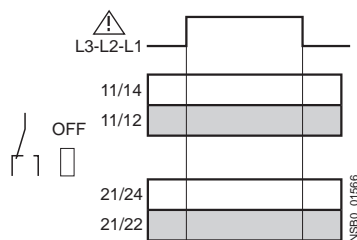

3UG45 12 monitoring relays

The 3UG45 12 line monitoring relay monitors three-phase networks with regard to phase sequence, phase failure and phase unbalance of 10 %. Thanks to a special measuring method, a phase failure is reliably detected in spite of the wide voltage range from 160 to 690 V AC and feedback through the load of up to 90 %. The device has an internal power supply and works using the closed-circuit principle. No adjustments are required. When the mains supply is switched on, the green LED is lit. If the phase sequence at the terminals L1-L2-L3 is correct, the output relay picks up. If the phase sequence is wrong, the red LED flashes and the output relay remains in its rest position. If a phase fails, the red LED is permanently lit and the output relay drops.

Note:
The red LED is a fault diagnostic indicator and does not show the current relay status. The 3UG45 12 monitoring relay is suitable for line frequencies of 50/60 Hz.

Phase failure

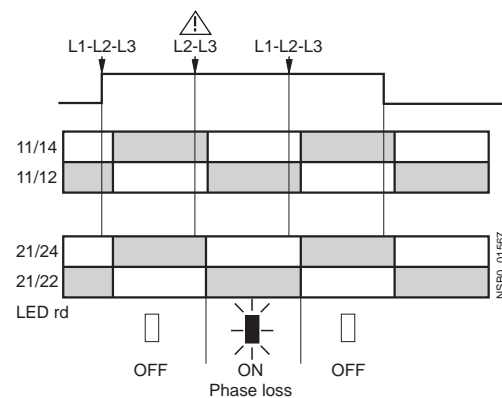

Wrong phase sequence

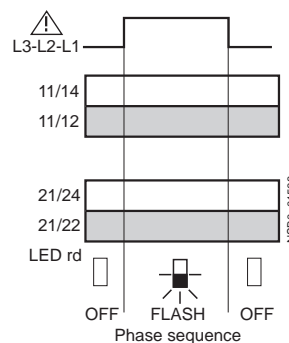

Monitoring Relays

3UG Monitoring Relays for Electrical and Additional Measurements

Line monitoring

3UG45 13 monitoring relays

The 3UG45 13 line monitoring relay monitors three-phase networks with regard to phase sequence, phase failure, phase unbalance of 20 % and undervoltage. The device has an internal power supply and works using the closed-circuit principle. The hysteresis is 5 %. The integrated response delay time is adjustable from 0 to 20 s and responds to undervoltage. If the direction is incorrect, the device switches off immediately. Thanks to a special measuring method, a phase failure is reliably detected in spite of the wide voltage range from 160 to 690 V AC and feedback through the load of up to 80 %. When the mains supply is switched on, the green LED is lit. If the phase sequence at the terminals L1-L2-L3 is correct, the output relay picks up. If the phase sequence is wrong, the red LED flashes and the output relay remains in its rest position. If a phase fails, the red LED is permanently lit and the output relay drops.

Note:

The red LED is a fault diagnostic indicator and does not show the current relay status. The 3UG45 13 monitoring relay is suitable for line frequencies of 50/60 Hz.

Phase failure and undervoltage

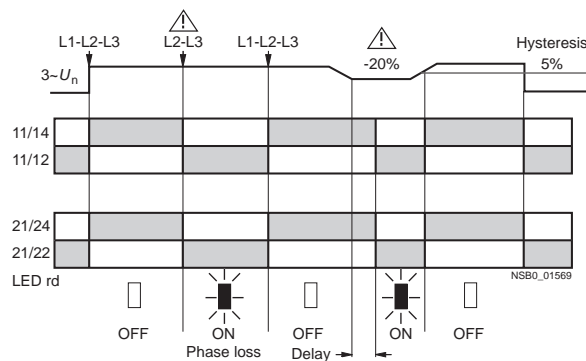

Wrong phase sequence

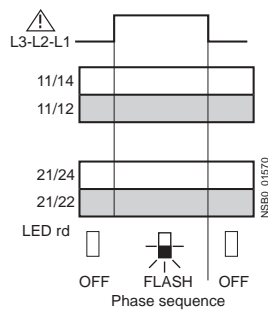

3UG46 14 monitoring relays

The 3UG46 14 line monitoring relay has a wide voltage range and an internal power supply. The device is equipped with a display and is parameterized using three buttons. It monitors three-phase networks with regard to phase unbalance from 5 to 20 %, phase failure, undervoltage and phase sequence. The hysteresis is adjustable from 1 to 20 V. In addition, the device has a response delay and ON delay from 0 to 20 s in each case. The integrated response delay time responds to phase unbalance and undervoltage. If the direction is incorrect, the device switches off immediately. Thanks to a special measuring method, a phase failure is reliably detected in spite of the wide voltage range from 160 to 690 V AC and feedback through the load.

The 3UG46 14 monitoring relay can be operated on the basis of either the open-circuit or closed-circuit principle and with manual or auto RESET.

With the closed-circuit principle selected

Wrong phase sequence

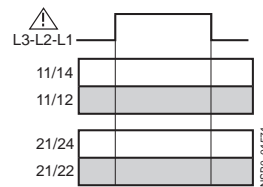

Phase failure

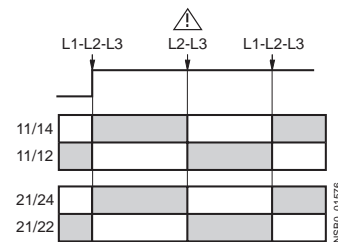

Undervoltage

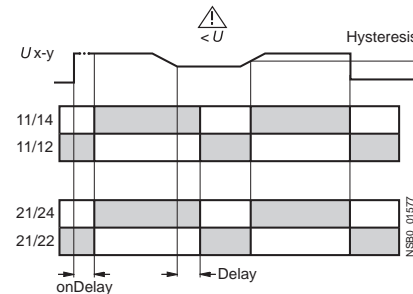

Unbalance

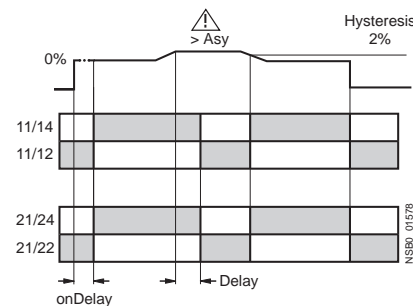

Monitoring Relays

3UG Monitoring Relays for Electrical and Additional Measurements

Line monitoring

3UG46 15/3UG46 16 monitoring relays

The 3UG46 15/3UG46 16 line monitoring relay has a wide voltage range and an internal power supply. The device is equipped with a display and is parameterized using three buttons. The 3UG46 15 device monitors three-phase networks with regard to phase failure, undervoltage, overvoltage and phase sequence. The 3UG46 16 monitoring relay monitors the neutral conductor as well. The hysteresis is adjustable from 1 to 20 V. In addition the device has two separately adjustable delay times for overvoltage and undervoltage from 0 to 20 s in each case. If the direction is incorrect, the device switches off immediately. Thanks to a special measuring method, a phase failure is reliably detected in spite of the wide voltage range from 160 to 690 V AC and feedback through the load of up to 80 %.

The 3UG46 15/3UG46 16 monitoring relay can be operated on the basis of either the open-circuit or closed-circuit principle and with manual or auto RESET.

With the closed-circuit principle selected

Wrong phase sequence

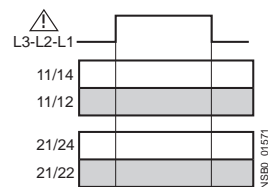

Phase failure

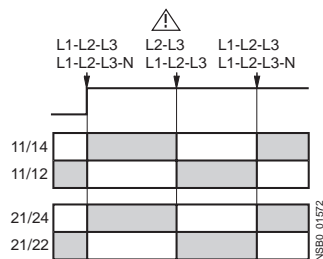

Undervoltage

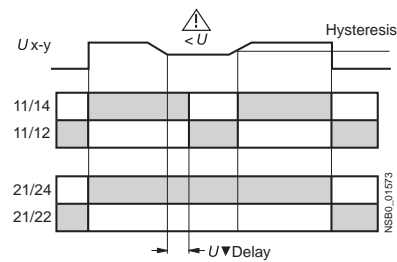

Overvoltage

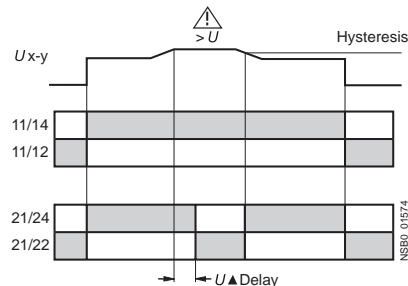

3UG46 17/3UG46 18 monitoring relays

The 3UG46 17/ 3UG46 18 line monitoring relay has an internal power supply and can automatically correct a wrong direction of rotation. Thanks to a special measuring method, a phase failure is reliably detected in spite of the wide voltage range from 160 to 690 V AC and feedback through the load of up to 80 %. The device is equipped with a display and is parameterized using three buttons. The 3UG46 17 line monitoring relay monitors three-phase networks with regard to phase sequence, phase failure, phase unbalance, undervoltage and overvoltage. The 3UG46 18 monitoring relay monitors the neutral conductor as well. The hysteresis is adjustable from 1 to 20 V. In addition the device has delay times from 0 to 20 s in each case. The times respond to overvoltage, undervoltage, phase failure and phase unbalance. The 3UG46 17/3UG46 18 monitoring relay can be operated on the basis of either the open-circuit or closed-circuit principle and with manual or auto RESET.

The one changeover contact is used for warning or switching off in the event of line faults (voltage, unbalance), the other responds only to a wrong phase sequence. In conjunction with a contactor reversing assembly it is thus possible to change the direction automatically.

With the closed-circuit principle selected

Phase failure

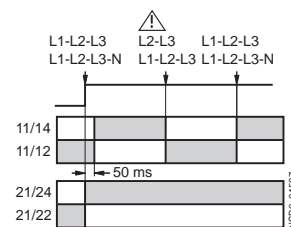

Undervoltage

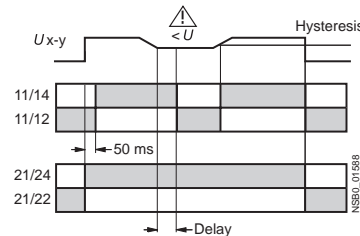

Overvoltage

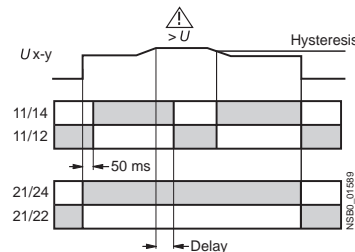

Unbalance

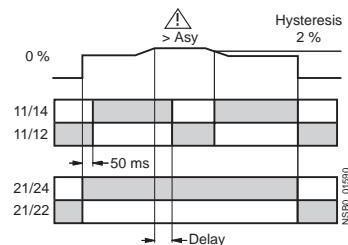

Monitoring Relays

3UG Monitoring Relays for Electrical and Additional Measurements

Line monitoring

Technical specifications

		3UG45 11- ..N20	3UG45 11- ..P20	3UG45 11- ..Q20	3UG45 12	3UG45 13	3UG46 14	3UG46 15 3UG46 16 3UG46 17 3UG46 18	
General data									
Rated control supply voltage U_s	V	160 ... 260	320 ... 500	420 ... 690	160 ... 690				
Rated frequency	Hz	50/60							
Rated output, typical									
• At 230 V AC	W/VA	2/4	--	--	2/2.5				
• At 400 V AC	W/VA	--	2/8	--	2/3.5				
• At 460 V AC	W/VA	--	--	2/8	2/4				
Width	mm	22.5							
RESET		--						automatic/manual	
Function principle		Closed-circuit						Closed-circuit, open-circuit (3UG46 17/ 3UG46 18: closed-circuit)	
Availability time after application of U_s	ms	200			1000				
Response time on occurrence of a fault	ms	300							
Adjustable tripping delay time	s	--					0.1 ... 20		
Adjustable ON-delay time	s	--						0.1 ... 20	--
Mains buffering time, typical	ms	10			30				
Rated insulation voltage U_i	V	690							
Degree of pollution 3 Overvoltage category III acc. to VDE 0110									
Rated impulse withstand voltage	kV	6							
Permissible ambient temperature									
• During operation	°C	-25 ... +60							
• During storage	°C	-40 ... +85							
EMC tests¹⁾		IEC 60947-1/IEC 61000-6-2/IEC 61000-6-4							
Degree of protection									
• Enclosures		IP40							
• Terminals		IP20							
Vibration resistance acc. to IEC 60068-2-6	Hz/mm	1-6/15; 6-500, 20 m/s ²							
Shock resistance acc. to IEC 60068 Part 2-27	g/ms	15/11							
Conductor cross-section		M 3 (standard screwdriver size 2 and Pozidriv 2)							
• Screw-type connection									
- Solid	mm ²	1 x (0.5 ... 4)/2 x (0.5 ... 2.5)							
- Finely stranded with end sleeve	mm ²	1 x (0.5 ... 2.5)/2 x (0.5 ... 1.5)							
- AWG conductors, solid or stranded	AWG	2 x (20 ... 14)							
- Tightening torque	Nm	0.8 ... 1.2							
• Spring-loaded terminals									
- Solid	mm ²	2 x (0.25 ... 1.5)							
- Finely stranded, with end sleeves acc. to DIN 46228	mm ²	2 x (0.25 ... 1.5)							
- Finely stranded	mm ²	2 x (0.25 ... 1.5)							
- AWG conductors, solid or stranded	AWG	2 x (24 ... 16)							
Measuring circuits									
Measuring range	V	160 ... 260	320 ... 500	420 ... 690	160 ... 690				
Setting range	V					200...690	160...690		
Measuring accuracy	%	--				±5			
Repeat accuracy at constant parameters	%	--				±1			
Setting accuracy		--				±10 % referred to upper limit of effective range		±1 V	
Accuracy of digital display		--				±1 digit			
Deviations for temperature deviations	%/°C	--				±0.1			
Hysteresis for voltage	V	--				5 % of upper limit of effective range		1 ... 20 V	
Hysteresis for unbalance	%	--						2 % of limit value	2 % of limit value for 3UG46 17/ 3UG46 18
Deviation for frequency fluctuation	%	--				±1 %			

1) Note: This is a Class A product. In the household environment this device may cause radio interference. In this case the user must introduce suitable measures.

Monitoring Relays

3UG Monitoring Relays for Electrical and Additional Measurements

Line monitoring

	3UG45 11- ..N20	3UG45 11- ..P20	3UG45 11- ..Q20	3UG45 12	3UG45 13	3UG46 14	3UG46 15 3UG46 16 3UG46 17 3UG46 18
Control circuits							
Load capacity of the output relay							
• Thermal current limit I_{th}	A	5					
Rated operational current I_e at							
• AC-15/230 V/400 V	A	3					
• DC-13/24 V	A	1					
• DC-13/110 V	A	0.2					
• DC-13/230 V	A	0.1					
Minimum contact load at 17 V DC	mA	5					
Output relay with DIAZED fuse gl/Gg operational class	A	4					
Electrical endurance AC-15	Million operating cycles	0.1					
Mechanical endurance	Million operating cycles	10					

Dimensional drawings

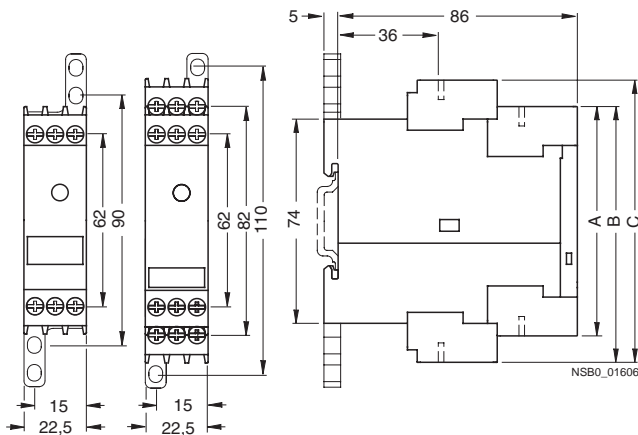

	A	B	C
Type	3UG45 11-A 3UG45 12-A	3UG45 11-B 3UG45 12-B 3UG45 13 3UG46 14 3UG46 15 3UG46 17	3UG46 16 3UG46 18
Removable terminal			
Spring-loaded terminal	84	94	103
Screw-type connection	83	92	102

Monitoring Relays

3UG Monitoring Relays for Electrical and Additional Measurements

Line monitoring

Schematics

3UG45 11-A
3UG45 12-A

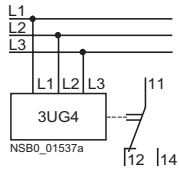

3UG45 11-B
3UG45 12-B
3UG45 13
3UG46 14
3UG46 15
3UG46 17

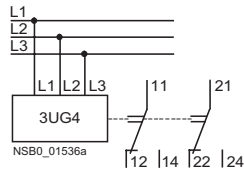

3UG46 16
3UG46 18

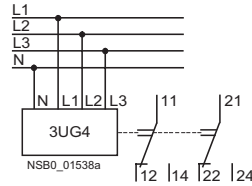

Position of the connection terminals

3UG45 11-A
3UG45 12-A

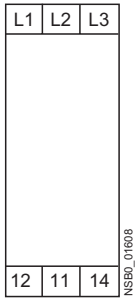

3UG45 11-B
3UG45 12-B
3UG45 13
3UG46 14
3UG46 15
3UG46 17

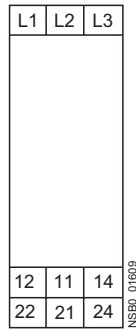

3UG46 16
3UG46 18

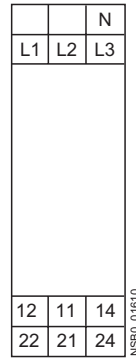

Monitoring Relays

3UG Monitoring Relays for Electrical and Additional Measurements

Voltage monitoring

Overview



The relays monitor single-phase AC and DC voltages against the set threshold for overshoot and undershoot. The products differ with regard to their power supply (internal or external).

Function

3UG46 33 monitoring relays

The 3UG46 33 voltage monitoring relay has an internal power supply and performs overshoot, undershoot or window monitoring of the voltage depending on how it is parameterized. The device is equipped with a display and is parameterized using three buttons.

The operating and measuring range extends from 17 V to 275 V AC/DC. The threshold values for overshoot or undershoot can be freely configured within this range. If one of these threshold values is reached, the output relay responds according to the set principle of operation as soon as the tripping delay time has elapsed. This delay time U_{Del} can be set from 0.1 to 20 s like the ON-delay time on_{Del} .

The hysteresis is adjustable from 0.1 to 150 V. The device can be operated on the basis of either the open-circuit or closed-circuit principle and with manual or auto RESET. One output changeover contact is available as signaling contact.

With the closed-circuit principle selected

Overvoltage

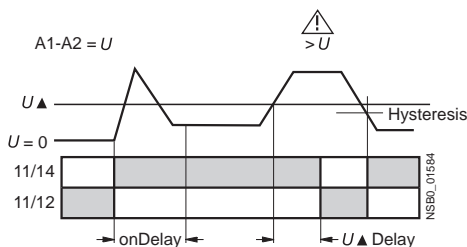

Undervoltage

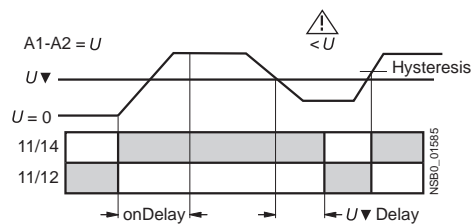

Window monitoring

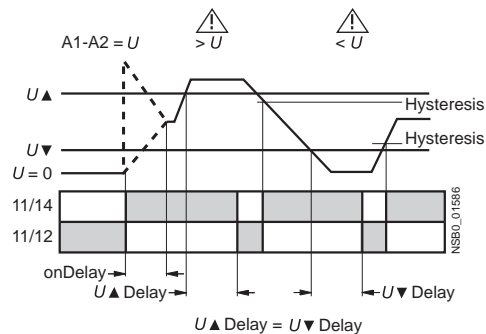

7

Monitoring Relays

3UG Monitoring Relays for Electrical and Additional Measurements

Voltage monitoring

3UG46 31/3UG46 32 monitoring relays

The 3UG46 31/3UG46 32 voltage monitoring relay is supplied with an auxiliary voltage of 24 V AC/DC or 24 to 240 V AC/DC and performs overshoot, undershoot or window monitoring of the voltage depending on how it is parameterized. The device is equipped with a display and is parameterized using three buttons.

The measuring range extends from 0.1 V to 60 V or from 10 to 600 V AC/DC. The threshold values for overshoot or undershoot can be freely configured within this range. If one of these threshold values is reached, the output relay responds according to the set principle of operation as soon as the delay time has elapsed. This delay time U_{Del} can be set from 0.1 to 20 s.

The hysteresis is adjustable from 0.1 to 30 V or 0.1 to 300 V. The device can be operated on the basis of either the open-circuit or closed-circuit principle and with manual or auto RESET. One output changeover contact is available as signaling contact.

With the closed-circuit principle selected

Overvoltage

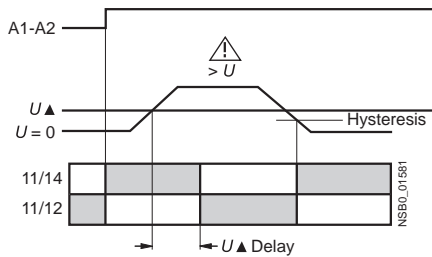

Undervoltage

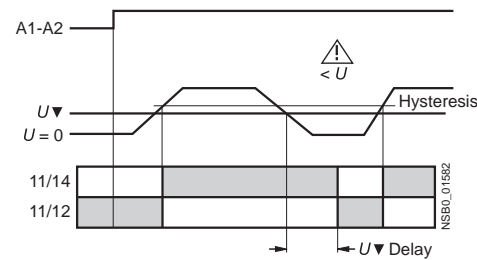

Window monitoring

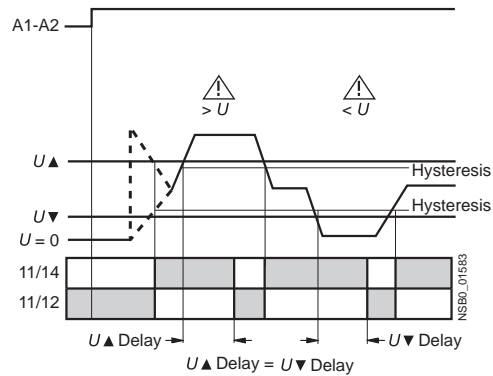

Monitoring Relays

3UG Monitoring Relays for Electrical and Additional Measurements

Voltage monitoring

Technical specifications

		3UG46 31- .AA	3UG46 31- .AW	3UG46 32- .AA	3UG46 32- .AW	3UG46 33
General data						
Rated control supply voltage U_s	V	24 AC/DC	24 ... 240 AC/DC	24 AC/DC	24 ... 240 AC/DC	17 ... 275 AC/DC
Rated frequency for AC	Hz	50/60				
Operating range	V	20.4 ... 27.6	20.4 ... 275	20.4 ... 27.6	20.4 ... 275	17 ... 275
Rated output	VA	2/4				
Width	mm	22.5				
RESET		Automatic/manual				
Availability time after application of U_s	ms	1000				
Response time on occurrence of a fault	ms	300				
Adjustable tripping delay time	s	0.1 ... 20				
Adjustable ON-delay time	s	--				
Mains buffering time , typical	ms	10				
Rated insulation voltage U_i Pollution degree 3 Overvoltage category III acc. to VDE 0110	V	300	--	690		300
Rated impulse withstand voltage U_{imp}	kV	4		6		4
Permissible ambient temperature						
• During operation	°C	-25 ... +60				
• During storage	°C	-40 ... +85				
EMC tests¹⁾		IEC 60947-1/IEC 61000-6-2/IEC 61000-6-4				
Degree of protection						
• Enclosures		IP40				
• Terminals		IP20				
Vibration resistance acc. to IEC 60068-2-6	Hz/mm	1-6/1S; 6-500, 20 m/s ²				
Shock resistance acc. to IEC 60068 Part 2-27	g/ms	15/11				
Conductor cross-section						
• Screw-type connection		M 3 (standard screwdriver size 2 and Pozidriv 2)				
- Solid	mm ²	1 x (0.5 ... 4)/2 x (0.5 ... 2.5)				
- Finely stranded with end sleeve	mm ²	1 x (0.5 ... 2.5)/2 x (0.5 ... 1.5)				
- AWG conductors, solid or stranded	AWG	2 x (20 ... 14)				
- Tightening torque	Nm	0.8 ... 1.2				
• Spring-loaded terminals						
- Solid	mm ²	2 x (0.25 ... 1.5)				
- Finely stranded, with end sleeves acc. to DIN 46228	mm ²	2 x (0.25 ... 1.5)				
- Finely stranded	mm ²	2 x (0.25 ... 1.5)				
- AWG conductors, solid or stranded	AWG	2 x (24 ... 16)				
Measuring circuits						
Permissible measuring range single-phase AC/DC voltage	V	0.1 ... 90		10 ... 650	17 ... 275	
Setting range single-phase voltage	V	0.1 ... 60		10 ... 600	17 ... 275	
Measuring frequency	Hz	40 ... 500			40 ... 500	
Measuring accuracy	%	5				
Repeat accuracy at constant parameters	%	1				
Accuracy of digital display		±1 digit				
Deviations for temperature fluctuations	%/°C	±1				
Hysteresis for single-phase voltage	V	0.1 ... 30		0.1 ... 300	0.1 ... 150	
Control circuits						
Load capacity of the output relay						
• Thermal current limit I_{th}	A	5				
Rated operational current I_e at						
• AC-15 230/400 V	A	3				
• DC-13 24 V	A	1				
• DC-13 110 V	A	0.2				
• DC-13 230 V	A	0.1				
Minimum contact load at 17 V DC	mA	5				
Output relay with DIAZED fuse gI/Gg operational class	A	4				
Electrical endurance AC-15	Million operating cycles	0.1				
Endurance with contactor relay	Million operating cycles	10				

1) Note: This is a Class A product. In the household environment this device may cause radio interference. In this case the user must introduce suitable measures.



Monitoring Relays

3UG Monitoring Relays for Electrical and Additional Measurements

Voltage monitoring

Dimensional drawings

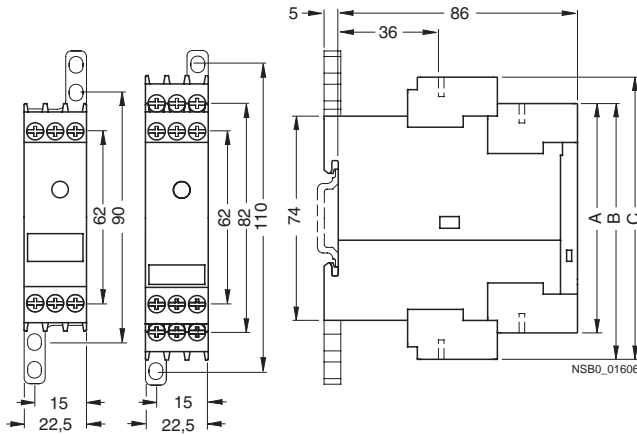

	B
Type	3UG46 31 3UG46 32 3UG46 33
Removable terminals	
Spring-loaded terminal	94
Screw-type connection	92

Schematics

3UG46 31
3UG46 32

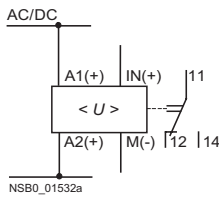

3UG46 31-.AW30
3UG46 32-.AW30

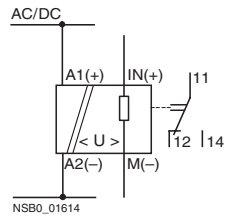

3UG46 33

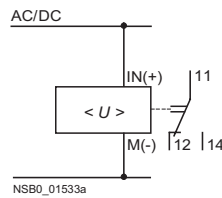

Position of the connection terminals

3UG46 31
3UG46 32

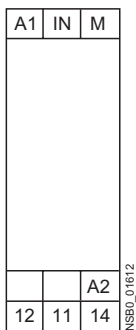

3UG46 33

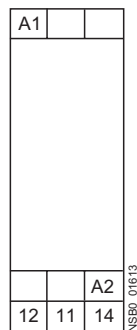

Monitoring Relays

3UG Monitoring Relays for Electrical and Additional Measurements

Current monitoring

Overview



The relays monitor single-phase AC and DC currents against the set threshold for overshoot and undershoot. They differ with regard to their measuring ranges and supply voltage types.

Function

3UG46 21/3UG46 22 monitoring relays

The 3UG46 21/3UG46 22 current monitoring relay is supplied with an auxiliary voltage of 24 V AC/DC or 24 to 240 V AC/DC and performs overshoot, undershoot or window monitoring of the current depending on how it is parameterized. The device is equipped with a display and is parameterized using three buttons.

The measuring range extends from 3 to 500 mA or 0.05 to 10 A. The threshold values for overshoot or undershoot can be freely configured within this range. If one of these threshold values is reached, the output relay responds according to the set principle of operation as soon as the tripping delay time I_{Del} has elapsed. This time and the ON-delay time on_{Del} are adjustable from 0.1 to 20 s.

The hysteresis is adjustable from 0.1 to 250 mA or 0.01 to 5 A. The device can be operated on the basis of either the open-circuit or closed-circuit principle and with manual or auto RESET. One output changeover contact is available as signaling contact.

With the closed-circuit principle selected

Current overshoot

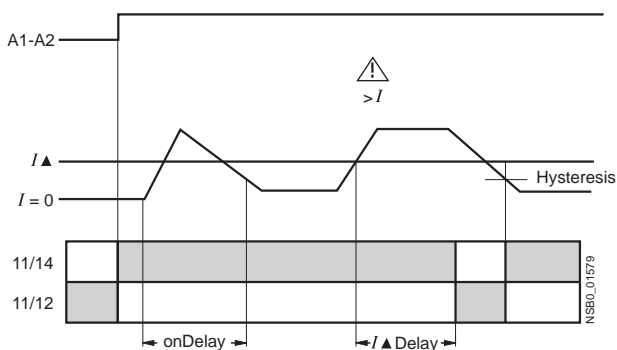

Current undershoot

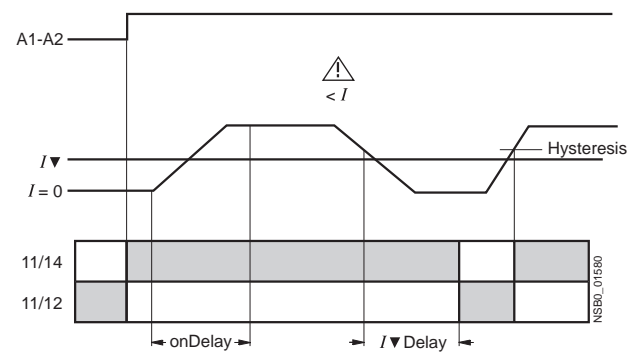

Window monitoring

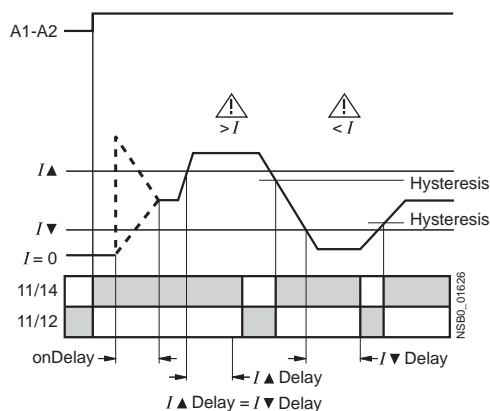

7

Monitoring Relays

3UG Monitoring Relays for Electrical and Additional Measurements

Current monitoring

Technical specifications

		3UG46 21-AA	3UG46 21-AW	3UG46 22-AA	3UG46 22-AW
General data					
Rated control supply voltage U_s	V	24	24 ... 240	24	24 ... 240
Rated frequency	Hz	50/60			
Operating range	V	20.4 ... 26.4			
Rated power	VA	2/4			
Width	mm	22.5			
RESET		Automatic/manual			
Availability time after application of U_s	ms	1000			
Response time on occurrence of a fault	ms	300			
Adjustable tripping delay time	s	0.1 ... 20			
Adjustable ON-delay time	s	0.1 ... 20			
Mains buffering time, typical	ms	10			
Rated insulation voltage U_i	V	300			
Degree of pollution 3 Overvoltage category III acc. to VDE 0110					
Rated impulse withstand voltage U_{imp}	kV	4			
Permissible ambient temperature					
• During operation	°C	-25 ... +60			
• During storage	°C	-40 ... +85			
EMC tests ¹⁾		IEC 60947-1/IEC 61000-6-2/IEC 61000-6-4			
Degree of protection					
• Enclosures		IP40			
• Terminals		IP20			
Vibration resistance acc. to IEC 60068-2-6	Hz/mm	1-6/15; 6-500.20 m/s ²			
Shock resistance acc. to IEC 60068 Part 2-27	g/ms	15/11			
Conductor cross-section					
• Screw-type connection		M 3 (standard screwdriver size 2 and Pozidriv 2)			
- Solid	mm ²	1 x (0.5 ... 4)/2 x (0.5 ... 2.5)			
- Finely stranded with end sleeve	mm ²	1 x (0.5 ... 2.5)/2 x (0.5 ... 1.5)			
- AWG conductors, solid or stranded	AWG	2 x (20 ... 14)			
- Tightening torque	Nm	0.8 ... 1.2			
• Spring-loaded terminals					
- Solid	mm ²	2 x (0.25 ... 1.5)			
- Finely stranded, with end sleeves acc. to DIN 46228	mm ²	2 x (0.25 ... 1.5)			
- Finely stranded	mm ²	2 x (0.25 ... 1.5)			
- AWG conductors, solid or stranded	AWG	2 x (24 ... 16)			
Measuring circuit					
Measuring range for single-phase AC/DC current	A	0.003 ... 0.6		0.05 ... 15	
Setting range for single-phase current	A	0.003 ... 0.5		0.05 ... 10	
Measuring accuracy	%	5			
Repeat accuracy at constant parameters	%	1			
Accuracy of digital display		± 1 digit			
Deviations for temperature fluctuations	%/°C	± 0.1			
Hysteresis for single-phase current		0.1 ... 250 mA		0.01 ... 5 A	
Control circuit					
Load capacity of the output relay					
• Thermal current limit I_{th}	A	5			
Rated operational current I_e at					
• AC-15 230/400 V	A	3			
• DC-13 24 V	A	1			
• DC-13 110 V	A	0.2			
• DC-13 230 V	A	0.1			
Minimum contact load at 17 V DC	mA	5			
Output relay for DIAZED fuse	A	4			
gI/Gg operational class					
Electrical endurance AC-15	Million operating cycles	0.1			
Endurance with contactor relay	Million operating cycles	10			

1) Note: This is a Class A product. In the household environment this device may cause radio interference. In this case the user must introduce suitable measures.

Monitoring Relays

3UG Monitoring Relays for Electrical and Additional Measurements

Current monitoring

Dimensional drawings

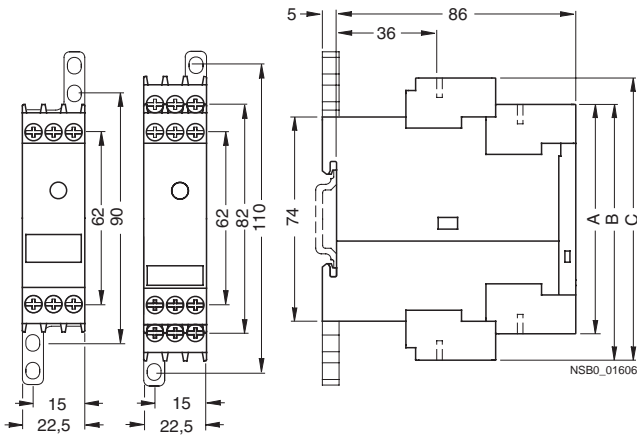

	B
Type	3UG46 21 3UG46 22
Removable terminals	
Spring-loaded terminal	94
Screw-type terminal	92

Schematics

3UG46 21-AA30
3UG46 22-AA30

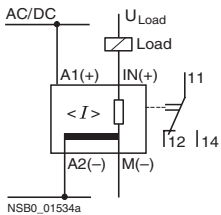

3UG46 21-AW30
3UG46 22-AW30

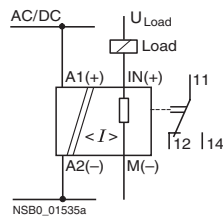

Position of the connection terminals

3UG46 21
3UG46 22

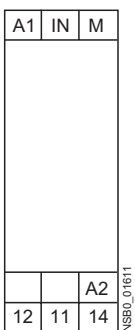

7

Monitoring Relays

3UG Monitoring Relays for Electrical and Additional Measurements

Power factor monitoring

Overview

The 3UG30 14 power factor monitoring device enables the load monitoring of motors.

Function

The 3UG30 14 monitoring relay is used for monitoring the load of motors by measuring the phase angle between voltage and current, i.e. the power factor. The output relays respond as long as the power factor lies between the upper and lower thresholds. These are set separately on the front using two potentiometers.

When the value of the power factor lies outside this range, the corresponding output relay will drop after a delay time T1, that can be set on the front, has elapsed. A fixed hysteresis prevents the output relay from continuously switching on and off when the measured value is close to the threshold.

The ON-delay T2 can be used to suppress the effects of motor start-up.

Important

It is important to ensure that the phases are connected in the correct sequence L1-L2-L3, otherwise the power factor will be evaluated incorrectly.

Note:

Power factor monitoring relays are connected in series after the motor contactor to ensure that the delay time for bridging start-up elapses after switch-on. For this reason, the output relay must not be connected in series with the supply voltage of the motor contactor, otherwise it would not be possible to switch on the load feeder. The minimum current must be at least 0.2 A.

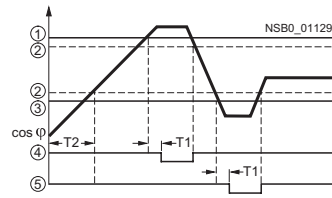

- ① Threshold value U_{max}
- ② Hysteresis
- ③ Threshold value U_{min}
- ④ Output relay $\cos \varphi > \cos \varphi_{max}$ (terminals 21, 22, 24)
- ⑤ Output relay $\cos \varphi < \cos \varphi_{min}$ (terminals 11, 12, 14)

Technical specifications

Type	3UG30/3UG35		
Load capacity of the output relay	Rated operational current I_e	A	max. 8
	AC-15/230 V	A	3
	DC-13/24 V	A	1
	DC-13/48 V	A	0.45
	DC-13/60 V	A	0.35
	DC-13/110 V	A	0.2
	DC-13/230 V	A	0.1
Minimum contact load	mA		5/17 V for a fault of 1 ppm
Output relay with DIAZED fuse¹⁾	gl/Gg operational class	A	4
Electrical endurance	Operating cycles		1×10^5
Mechanical endurance	Operating cycles		2×10^6
Ambient temperature	During operation	°C	-20 ... + 50
	During storage	°C	-30 ... + 70
Connection of conductors	Solid	mm ²	2 x (0.5 ... 2.5)
	Finely stranded, with end sleeves	mm ²	2 x (0.5 ... 1.5)
Degree of protection	Terminals		IP20
	Enclosures		IP40
Vibration resistance	acc. to IEC 60068-2-6	Hz/mm	10 ... 150/0.035

1) Short-circuits without any contact welding acc. to DIN VDE 0660, Part 200.

Monitoring Relays

3UG Monitoring Relays for Electrical and Additional Measurements

Power factor monitoring

Rated control supply voltage U_s	V	see Catalog LV 1 (L1/L2 also used to supply units)
Voltage tolerance	V	0.85 ... 1.15 × U_s
Maximum power consumption	VA	3
Frequency of the monitored line	Hz	50 ... 60
Setting range of power factor		0.1 ... 0.99 for lower and upper threshold
Hysteresis fixed	%	10 for power factor 0.4
		10 ... 30 for power factor 0.4
Setting accuracy	%	±10 referred to upper limit of effective range
Repeat accuracy at constant parameters	%	±0.8
Deviations for temperature fluctuations	%	±0.05/K
Delay time	T2, ON-delay T1 after reaching the threshold	s s
		0.5 ... 20; ±20 % 0.3 ... 3; ±20 %
Input circuit current range	A	0.5 ... 10
Input circuit peak current (< 1 s)	A	50
Input circuit input resistor L1/L2/L3	kΩ	2
Input circuit input resistor current IN1	Ω	0.02

Currents > 10 A only with current transformer.

Dimensional drawings

3UG30 14

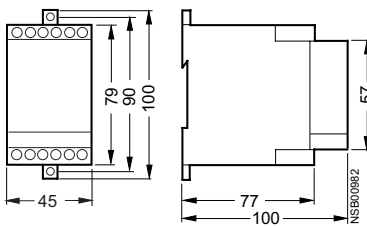

Schematics

3UG30 14

Three-phase operation, $I < 10 A\sim$

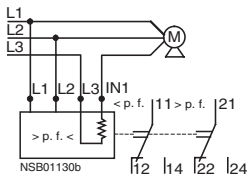

3UG30 14

Three-phase operation, $I > 10 A\sim$

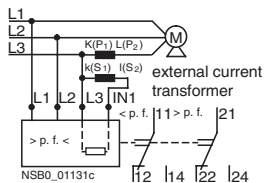

3UG30 14

Single-phase operation, 230 V~

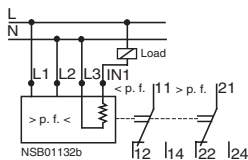

Monitoring Relays

3UG Monitoring Relays for Electrical and Additional Measurements

Insulation monitoring for ungrounded AC networks

Overview

Relay for monitoring the insulation resistance between the ungrounded single or three-phase AC supply and a protective ground conductor:

- Measuring principle with superimposed DC voltage
- Two selectable measuring ranges of 1 ... 110 k Ω
- Stepless setting within the measuring range
- Selectable:
 - Auto reset function with fixed hysteresis or
 - Storage of the tripping operation

- Test function with test button and terminal connections on the front
- Switching output: 1 CO contact
- Insulation fault indication with a red LED
- Supply voltage indication with a green LED
- Electro-magnetically compatible according to EN 50081 and EN 61000-6-2.

Function

The monitoring relay measures the insulation resistance between the ungrounded AC supply and an associated protective ground conductor.

A superposed DC measuring voltage is used to perform the measurement.

The monitoring relay is divided into two ranges for an insulation resistance range from 1 to 100 k Ω . A range switch on the front can be used to switch over between a 1 to 11 k Ω range and a 10 to 110 k Ω range. Within the selected range, the monitoring relay can be steplessly adapted to the respective insulation conditions.

If the insulation resistance undershoots the set threshold, the output relay is excited and the red LED (fault display) is lit.

If the insulation resistance exceeds 1.6 times (corresponding to 60 % hysteresis) the set threshold, the output relay will return to the rest position.

Note:

The monitoring relay is designed for AC supply systems. Series-connected rectifiers must be galvanically isolated from the measuring relay that is to be monitored.

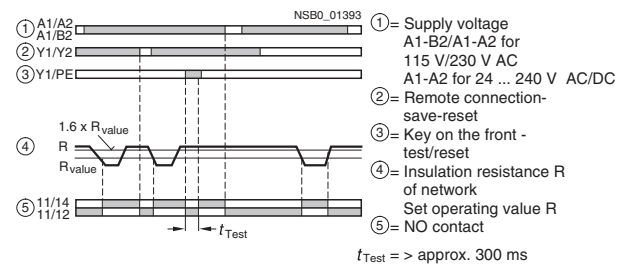

Test functions

The "Test" button on the front can be used to simulate a ground fault. If the "Test" button is pressed for at least 300 ms, the output relay is energized and the fault LED lights up. An external test button can be connected to terminal Y1. The function is activated by closing (> 300 ms).

Fault storage and RESET

If terminals Y1 and Y2 are jumpered, the monitoring relay is set to fault storage mode. If the set insulation resistance is undershot, the output relay is excited and remains tripped even after the insulation resistance rises above 1.6 times the set value again. Fault storage can be reset by briefly pressing the RESET button, briefly jumpering (< 300 ms) the Y1 and PE/ground terminals or by switching off and on the supply voltage.

Monitoring Relays

3UG Monitoring Relays for Electrical and Additional Measurements

Insulation monitoring
for ungrounded AC networks

Technical specifications

				3UG3 081
Control circuits				
Operating range of the control supply voltage		-15 % ... +10 %		
Rated power	24 ... 240 V AC/DC	VAW	8/2	
	110 ... 130 V AC	VA	3	
	220 ... 240 V AC	VA	3	
Frequency of the rated control supply voltage		Hz	50 ... 60	
Measurement circuits L/PE/ground				
• Operating value		k	1 ... 110	
• Minimum internal resistance for AC		k	100	
• Minimum internal resistance for DC		k	100	
• DC measurement voltage		V	30 DC	
• Insulation voltage		V	415 AC	
• Reset/test function terminals (max. 10 m)			Y1-Y2	
• Delay time in case of response		s	1	
Output relay		1 CO contact, open-circuit principle		
General data				
Rated insulation voltage U_i	between supply, measurement, and output circuit	V	400 acc. to IEC 60947-1	
Overtoltage category	acc. to IEC 664		III	
Degree of pollution	acc. to IEC 664		3	
Impulse withstand voltage U_{imp}	acc. to VDE 0435, Part 303	kV	4	
Degree of protection	acc. to EN 60529		IP50 enclosure, IP20 terminals	
Shock resistance	acc. to IEC 60068 Part 2-27	g/ms	10	
Vibration resistance	acc. to IEC 60068-2-6	Hz/mm	10-55/0.35	
Permissible ambient temperature	• During operation	°C	-25 ... 65	
	• During storage	°C	-40 ... 85	
Permissible mounting position		Any		
Conductor cross-section	Solid	mm ²	2 x 0.75 ... 2.5	
	Finely stranded with end sleeve	mm ²	2 x 0.75 ... 2.5	

Dimensional drawings

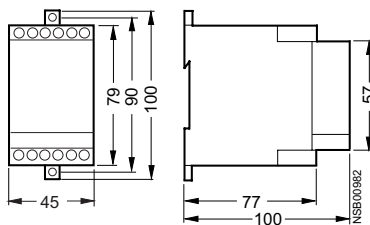

Monitoring Relays

3UG Monitoring Relays for Electrical and Additional Measurements

Insulation monitoring for ungrounded DC networks

Overview

Relay for monitoring the insulation resistance between ungrounded pure DC networks and a protective-ground conductor:

- Measuring principle for differential current measurement
- Response threshold can be set continuously from 10 to 110 k Ω
- Selectable
 - Auto reset function with hysteresis or
 - Storage of the tripping operation

- Front selector switch for open-circuit and closed-circuit principle for the output relay
- Test function with test buttons on the front for L+ and L- and over terminal connections
- Switching output: 1 CO contact
- Insulation fault indicator for L+ and L- through two red LEDs
- Supply voltage indication with a green LED
- Electro-magnetically compatible according to EN 50081 and EN 61000-6-2

Function

The monitoring relay measures the insulation voltage between the positive and negative supply voltage in an ungrounded DC network and a corresponding protective conductor.

The measurement is based on the DC residual current measurement principle. The response value can be adjusted steplessly in the range from 10 to 110 k Ω and thus can be adapted to the corresponding conditions. If the insulation resistance falls below the set response value, the output relay triggers (depending on the setting of the open/closed-circuit principle selector switch) and a fault LED lights up.

A ground fault is evaluated separately for L+ and L- and indicated by means of a corresponding LED.

Note:

Due to the measurement principle, a symmetrical ground fault on terminals L+ and L- cannot be evaluated.

Test function

A ground fault can be simulated using the Test L+ and Test L- buttons on the front. If the test button is pressed for at least 1 s, the status of the output relay changes and the corresponding fault LED lights up.

An external test button can be connected to terminals Y1-Y3 for L+ and terminals Y4-Y3 for L-. The function is triggered by means of a NO contact.

Fault storage and RESET

If terminals Y2 and Y3 are linked, the monitoring relay is set to fault storage mode.

If the insulation resistance falls below the set value, the output relay triggers (depending on the setting of the open/closed circuit selector switch), and stays in this state even if the insulation resistance rises again above the hysteresis value (typical: 2 times the set value). This fault storage can be deleted by pressing and releasing the L+ RESET button, opening the Y2-Y3 connection or by switching off the supply voltage.

Open/closed-circuit principle selector switch

The function principle of the output relay can be adjusted by means of a selector switch on the front panel.

If the relay is to respond in the event of a fault (contact symbol open), the open-circuit principle must be selected. If the relay however is to trigger in the event of a fault (contact symbol closed), the closed-circuit principle must be selected.

Note:

The position of the selector switch has no effect upon the fault LEDs. The LEDs always light up if the insulation resistance on L+ or L- falls below the set value.

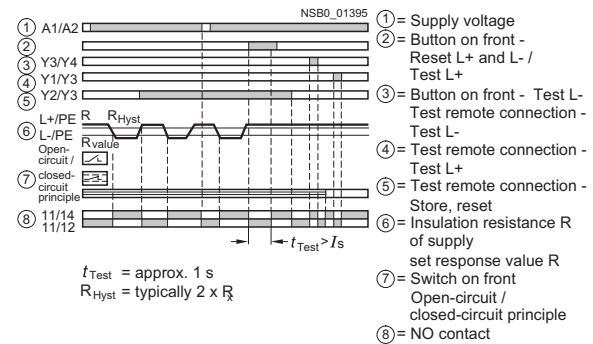

Monitoring Relays

3UG Monitoring Relays for Electrical and Additional Measurements

Insulation monitoring
for ungrounded DC networks

Technical specifications

				3UG30 82
Control circuits				
Operating range of the control supply voltage		-15 % ... +10 %		
Rated power	24 ... 240 V AC	VAW	8/2	
Frequency of the rated control supply voltage		Hz	50 ... 60	
Measuring circuits				
• Operating value		k	10 ... 110	
• Minimum internal resistance for DC		k	57	
• Measurement DC voltage		V	24 ... 240	
• Max. DC insulation voltage (L+/PE/ground, L-/PE/ground)		V DC	300	
• Reset/test function terminals (max. 10 m)			Y1/Y3, Y4/Y3	
• Delay time in case of response		s	1	
Output relay		1 changeover contact, open-circuit or closed-circuit principle		
General data				
Rated insulation voltage U_i	between supply, measurement, and output circuit	V	400	
Insulation resistance	acc. to IEC 664		III	
Overvoltage category	acc. to IEC 664		3	
Degree of pollution	acc. to IEC 664		3	
Impulse withstand voltage U_{imp}	acc. to VDE 0435, Part 303	V	4000	
Degree of protection	acc. to EN 60529		IP50 enclosure, IP20 terminals	
Shock resistance	acc. to IEC 60068 Part 2-27	g/ms	10	
Vibration resistance	acc. to IEC 60068-2-6	Hz/mm	10-55/0,35	
Permissible ambient temperature				
• During operation		°C	-25 ... + 65	
• During storage		°C	-40 ... + 85	
Permissible mounting position		any		
Conductor cross-section	Solid	mm ²	2 x 0.75 ... 2.5	
	Finely stranded with end sleeve	mm ²	2 x 0.75 ... 2.5	

Dimensional drawings

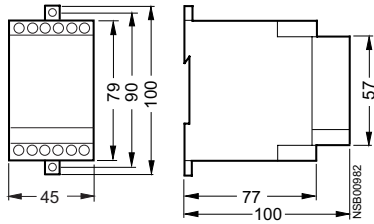

Monitoring Relays

3UG Monitoring Relays for Electrical and Additional Measurements

Level monitoring

Overview

The 3UG35 01 level monitoring relay is used together with the 2- or 3-pole sensors to monitor the levels of conductive liquids.

Function

The principle of operation is based on measuring the electrical resistance of the liquid between two immersion sensors and a reference terminal. If the measured value is lower than the sensitivity set at the front, the output relay changes its switching state. In order to exclude electrolytic phenomena in the liquid, the sensors are supplied with alternating current.

Two-level control: the output relay changes its switching state as soon as the liquid level reaches the maximum sensor, while the minimum sensor is submerged. The relay returns to its original switching state as soon as the minimum sensor no longer has contact with the liquid.

For safe resetting, the supply voltage must be interrupted for at least 0.5 s (T_3).

The delay times T_1 and T_2 of the output relay have not been included in the diagram in order to enhance clarity.

Note:

It is also possible to connect other resistance sensors to the Min and Max terminals in the range 5 to 100 k Ω , e.g. photoresistors, temperature sensors, encoders based on resistance etc. The monitoring relay can therefore also be used for other applications apart from monitoring the levels of liquids.

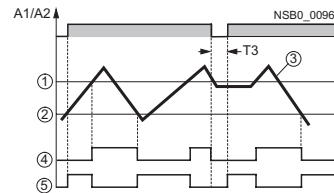

- ① Maximum level ¹⁾
- ② Minimum level ¹⁾
- ③ Monitored level
- ④ Output relay
Function OVER
- ⑤ Output relay
Function UNDER

¹⁾ Determined by the arrangement of the probes in the monitored liquid.

Monitoring Relays

3UG Monitoring Relays for Electrical and Additional Measurements

Level monitoring

Technical specifications

Type		3UG30/3UG35	
Load capacity of the output relay	Rated operational current I_o	A	max. 8
	AC-15/230 V	A	3
	DC-13/24 V	A	1
	DC-13/48 V	A	0.45
	DC-13/60 V	A	0.35
	DC-13/110 V	A	0.2
	DC-13/230 V	A	0.1
Minimum contact load		mA	5/17 V for a fault of 1 ppm
Output relay with DIAZED fuse¹⁾	gl/Gg operational class	A	4
Electrical endurance	Operating cycles		1×10^5
Mechanical endurance	Operating cycles		2×10^6
Ambient temperature	During operation	°C	-20 ... + 50
	During storage	°C	-30 ... + 70
Connection of conductors	Solid	mm ²	2 x (0.5 ... 2.5)
	Finely stranded, with end sleeves	mm ²	2 x (0.5 ... 1.5)
Degree of protection	Terminals		IP20
	Enclosures		IP40
Vibration resistance	acc. to IEC 60068-2-6	Hz/mm	10 ... 150/0.035

1) Short-circuits without any contact welding acc. to DIN VDE 0660 Part 200.

Rated control supply voltage U_s		V	see Catalog LV 1 (electrical isolation by means of a transformer)
Voltage tolerance			$0.85 \dots 1.1 \times U_s$
Maximum power consumption		W/VA	3/6
Function	Inlet or outlet monitoring		UNDER/OVER selector switch at the front
Sensitivity	Adjustable	k Ω	5 ... 100
Setting accuracy	at maximum sensitivity	%	± 30
Repeat accuracy	at constant parameters	%	± 0.1
Sensor length	max.	m	100
Electrode voltage	max.	V	24 (50/60 Hz)
Electrode current	max.	mA	1 (50/60 Hz)
Conductor capacity	of the sensor cable ¹⁾	nF	10
Delay time	• T1 at Max/M terminal	ms	Typical 500 (ON-delay with OVER, OFF-delay with UNDER)
	• T2 at Min/M terminal	ms	Typical 300 (OFF-delay with OVER, ON-delay with UNDER)
Mains buffering time		ms	300

1) The sensor cable does not necessarily have to be shielded, but it is not recommended to lay this cable parallel to the power supply lines. It is also possible to use a shielded cable, whereby the shield has to be connected to the M terminal.

7

Monitoring Relays

3UG Monitoring Relays for Electrical and Additional Measurements

Speed monitoring

Overview

The 3UG30 51 monitoring relay is used together with a sensor to monitor drives for underspeeding.

Function

The underspeed monitoring relay operates according to the principle of retriggerable OFF-delay. During the time (value) set on the front panel, another pulse must arrive at input IN1 or IN2 to ensure that the output relay remains picked up. The monitoring relay evaluates the rising edge of the signal, i.e. a continuous signal is also recognized as a missing pulse. If the retrigger pulse does not arrive, indicating a reduction in speed, the output relay drops. In order to be able to start a drive, the output relay remains picked up during the ON-delay time T, even if the speed is still below the set value (motor starting override time). The first pulse must come within this time.

The monitoring relay can be used for all functions where a continuous pulse signal needs to be monitored (belt travel monitoring, completeness monitoring, passing monitoring, clock-time monitoring).

Speed monitoring without memory (NO MEMORY)

When the speed of the drive drops below the set value, the output relay drops. It picks up again when the speed is greater than the set value plus the fixed hysteresis.

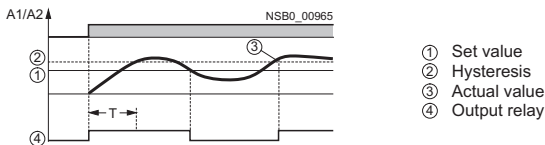

Speed monitoring with memory (MEMORY)

When the output relay drops, this state remains stored even when the speed reaches a permissible value again. The stored state can be ended by a control signal at the reset terminal or by interrupting the supply voltage for at least 200 ms.

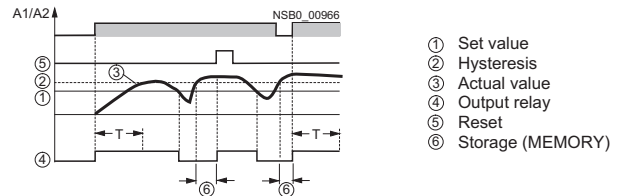

Technical specifications

Type		3UG30/3UG35	
Load capacity of the output relay	Rated operational current I_e	A	max. 8
	AC-15/230 V	A	3
	DC-13/24 V	A	1
	DC-13/48 V	A	0.45
	DC-13/60 V	A	0.35
	DC-13/110 V	A	0.2
	DC-13/230 V	A	0.1
Minimum contact load		mA	5/17 V for a fault of 1 ppm
Output relay with DIAZED fuse¹⁾	gl/Gg operational class	A	4
Electrical endurance	Operating cycles		1×10^5
Mechanical endurance	Operating cycles		2×10^6
Ambient temperature	During operation	°C	-20 ... + 50
	During storage	°C	-30 ... + 70
Connection of conductors	Solid	mm ²	2 x (0.5 ... 2.5)
	Finely stranded, with end sleeves	mm ²	2 x (0.5 ... 1.5)
Degree of protection	Terminals		IP20
	Enclosures		IP40
Vibration resistance	acc. to IEC 60068-2-6	Hz/mm	10 ... 150/0.035

1) Short-circuits without any contact welding acc. to DIN VDE 0660 Part 200.

Monitoring Relays

3UG Monitoring Relays for Electrical and Additional Measurements

Speed monitoring

Type		3UG30 51	
Rated control supply voltage U_s	V	See Catalog LV 1 (for AC voltages with electrical isolation by means of transformer, 24 V DC without electrical isolation)	
Voltage tolerance		0.85 ... 1.15 x U_s	
Maximum power consumption	W/VA	4/5	
Set value	%	Adjustable to 10 ... 100 of the selected time setting range	
Hysteresis	%	Typical 5 of the set value	
Setting accuracy	%	10 referred to upper limit of time setting range	
Repeat accuracy	at constant parameters	%	±0.5
Deviations	with temperature fluctuations	%/°C	0.1
ON-delay T	s	Adjustable to 0.3 ... 30 ±10 %	
Signal input IN1 ¹⁾	(Input resistance 16 k)	V	Max. voltage 30, 3-wire sensor, pnp operation
Signal input IN2 ¹⁾	(Input resistance 1 k)		Floating contact, 2-wire NAMUR sensor
Voltage level for reliable operation	Level 1	V	4.5 ... 30
	Level 0	V	0 up to 1
Sensor supply	+24 V/0 V	mA	max. 50 at 24 V (20 ... 35 V) DC
	+8 V2	mA	1 DC 8.2 V
Measuring range, selectable (rotary switch on front)			
Time setting range			
• 0.1 ... 1 s	- Frequency - Revolutions	Hz min ⁻¹	10 ... 1 600 ... 60
• 1 ... 10 s	- Frequency - Revolutions	Hz min ⁻¹	1 ... 0.1 60 ... 6
• 0.1 ... 1 min	- Frequency - Revolutions	Hz min ⁻¹	0.17 ... 0.017 10 ... 1
• 1 ... 10 min	- Frequency - Revolutions - Minimum pulse duration of signal - Minimum interval between 2 pulses	Hz min ⁻¹ ms ms	0.017 ... 0.0017 1 ... 0.1 5 5
Function mode setting	with or without memory	Rotary switch on front panel	
Availability time after application of U_s		ms	200
Mains buffering time		ms	10

1) The sensors are not included in the scope of supply.

Dimensional drawings

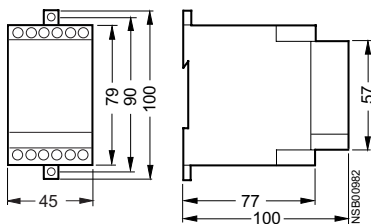

Schematics

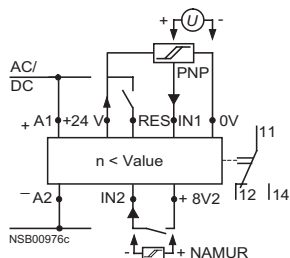

Monitoring Relays

3RS10, 3RS11 Temperature Monitoring Relays

General data

Overview

The 3RS10 and 3RS11 temperature monitoring relays can be used for measuring temperatures in solid, liquid and gas media. The temperature is sensed by the sensor in the medium, evaluated by the device and monitored for overshoot or undershoot or for staying within an operating range (window function).

The range comprises adjustable analog units with one or two threshold values, digital units to DIN 3440, which are also a good alternative to temperature controls for the low-end range, and digital units for up to 3 sensors which have been optimized for monitoring large motors.

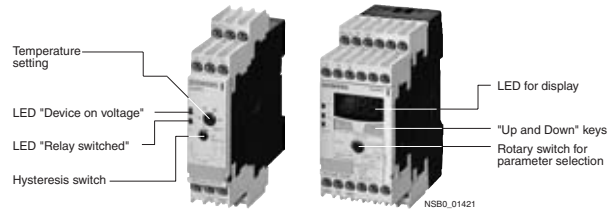

Design

The temperature monitoring relays comply with:

- IEC 60721-3-3 "Environmental conditions"
- IEC 60947-5-1; VDE 0660 "Low-voltage controlgear, switchgear and systems – Electromechanical controlgear"
- EN 61000-6-4 "Basic technical standard for emitted interference (Industry)"
- EN 61000-6-2 "Basic technical standard for interference immunity (Industry)"
- EN 50042 "Designations for terminals"
- UL/CSA
- DIN 3440 (3RS10 40, 3RS11 40, 3RS10 42, 3RS11 42).

Connection of resistance-type thermometers

2-wire measurement

When 2-wire temperature sensors are used, the resistances of the sensor and wiring are added. The resulting systematic error must be taken into account when the signal evaluator is calibrated. A jumper must be clamped between terminals T2 and T3 for this purpose.

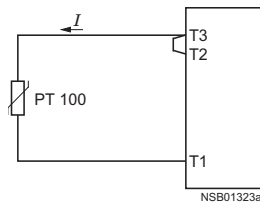

Wiring errors

The errors that are generated by the wiring comprise approximately 2.5 K/Ω. If the resistance of the wiring is not known and cannot be measured, the wiring errors can also be estimated using the following table.

Temperature drift depending on the length and cross-section of the leads with PT100 sensors and an ambient temperature of 20 °C, in K:

Cable length m	Cross-section mm ²			
	0.5	0.75	1	1.5
0	0.0	0.0	0.0	0.0
10	1.8	1.2	0.9	0.6
25	4.5	3.0	2.3	1.5
50	9.0	6.0	4.5	3.0
75	13.6	9.0	6.8	4.5
100	18.1	12.1	9.0	6.0
200	36.3	24.2	18.1	12.1
500	91.6	60.8	45.5	30.2

3-wire measurement

To minimize the effects of the line resistances, a three-wire circuit is often used. Using the additional wire, two measuring circuits can be formed of which one is used as a reference. The signal evaluator can then automatically calculate the line resistance and take it into account.

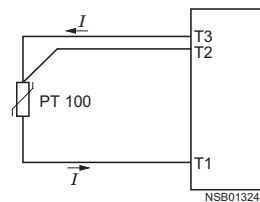

Monitoring Relays

3RS10, 3RS11 Temperature Monitoring Relays

General data

Connection of thermocouples

Based on the thermo-electrical effect, a differential temperature measurement will be performed between the measuring point and the signal evaluator.

This principle assumes that the signal evaluator knows the temperature at the clamping point (T2). For this reason, the 3RS11 temperature monitoring relay has an integral compensator that determines this comparison temperature and builds it into the result of the measurement. Therefore, the thermal sensors and cables must be insulated.

The absolute temperature is calculated from the ambient temperature of the signal evaluator and the temperature difference measured by the thermocouple.

Temperature detection is therefore possible (T1) without needing to know the precise ambient temperature of the clamping point at the signal evaluator (T2).

The connecting cable is only permitted to be extended using connecting leads that are made from the same material as the thermocouple. If a different type of conductor is used, an error will result in the measurement.

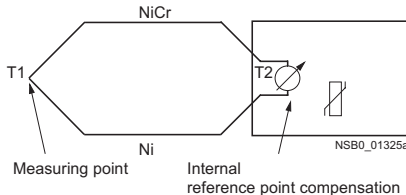

You can find more information on the Internet at:

<http://www.feldgeraete.de/76/produkte/fuw.html>
<http://www.ephy-mess.de>

or from

EPHY-MESS GmbH (see Appendix, External Partners)

Function

Once the temperature has reached the set threshold ϑ_1 , the output relay K1 changes its output state as soon as the set time t has elapsed (K2 responds in the same manner to ϑ_2). The time delay can only be adjusted with digital units (on analog units, $t = 0$).

The relays return to their original state as soon as the temperature reaches the set hysteresis value.

Temperature overshoot

Closed-circuit principle

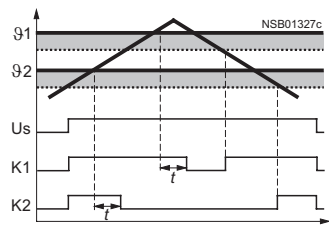

Temperature undershoot

Closed-circuit principle

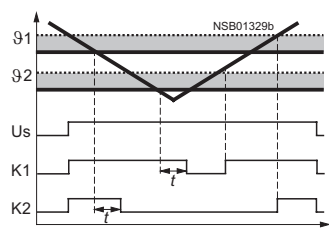

Monitoring Relays

3RS10, 3RS11 Temperature Monitoring Relays

General data

Window monitoring (digital units only)

Once the temperature has reached the upper threshold ϑ_1 , the output relay K1 changes its output state as soon as the set time t has elapsed. The relay returns to its original state as soon as the temperature reaches the set hysteresis value.

K2 responds in the same manner to the lower threshold of ϑ_2 .

Closed-circuit principle

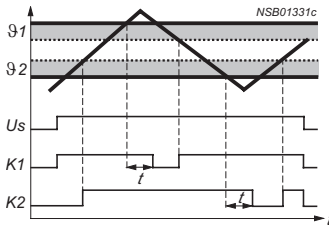

Principle of operation with memory function (3RS10 42, 3RS11 42), based on the example of temperature undershoot using the closed-circuit principle

Once the temperature has reached the set threshold ϑ_1 , the output relay K1 changes its output state as soon as the set time t has elapsed (K2 responds in the same manner to ϑ_2). The relays only return to the original state when the temperature falls below the set hysteresis value and when terminals Y3 and Y4 have been briefly jumpered.

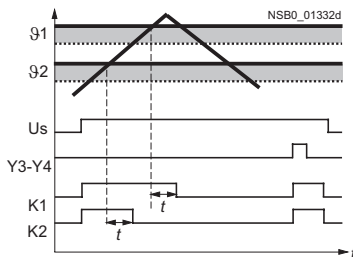

Characteristic curves

For thermocouples

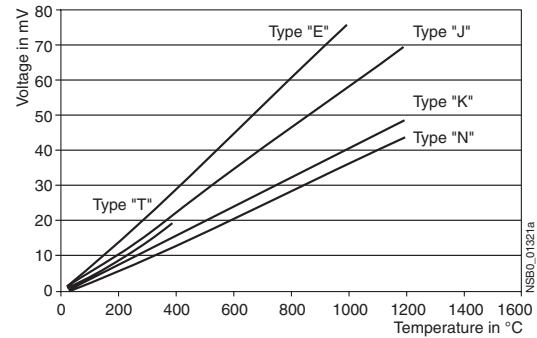

For resistance sensors

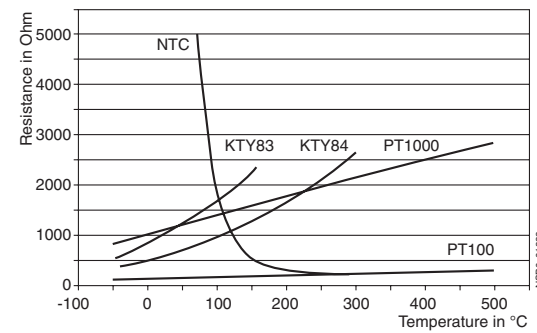

Monitoring Relays

3RS10, 3RS11 Temperature Monitoring Relays

Relays, analog adjustable

Overview

The 3RS10/3RS11 analog temperature monitoring relays can be used for measuring temperatures in solid, liquid and gas media. The temperature is sensed by the sensors in the medium,

evaluated by the device and monitored for overshoot or undershoot. When the threshold values are reached, the output relay switches on or off depending on the setting.

Technical specifications

Type	3RS10 00	3RS10 10	3RS11 00	3RS11 01	3RS10 20	3RS10 30	3RS11 20	3RS11 21
General data								
Sensor type	PT100		TC type J	TC type K	PT100		TC type J	TC type K
Width	mm	22.5						
Operating range	0.85 ... 1.1 x U _s							
Rated power	W/VA	< 2/4						
Auxiliary circuits								
Contacts	1 NO + 1 NC				1 CO + 1 NO			
Rated operational currents I_e								
• AC-15 at 230 V, 50 Hz	A	3						
• DC-13 at:								
- 24 V AC	A	1						
- 240 V AC	A	0.1						
DIAZED fuse								
• gI/Gg operational class	A	4						
Short-circuit current (at 250 V)	kA	1						
Electrical endurance	100000							
AC-15 at 3 A								
Mechanical endurance	3 x 10 ⁶							
Mechanical operating cycles								
Tripping units								
• Measuring accuracy at 20 °C ambient temperature (T₂₀)	Typical < ±5 % from upper limit of scale							
• Reference point accuracy	--	< ±5 K		--	< ±5 K			
• Deviations due to ambient temperature in % from measuring range	< 2	< 3		< 2	< 3			
• Hysteresis settings								
- For temperature 1	2 ... 20 % from upper limit of scale							
- For temperature 2	5 % from upper limit of scale							
Sensor circuits								
• Typical sensor circuits								
- PT100	mA	Typical 1		--	Typical 1		--	
- PT1000	mA	Typical 0.2		--	Typical 0.2		--	
• Open-circuit detection	No							
• Short-circuit detection	No							
• 3-wire conductor connection¹⁾	Yes		--		Yes		--	
Enclosures								
Environmental influences								
Permissible ambient temperature	°C	-25 ... +60						
Permissible storage temperature	°C	-40 ... +80						
Permissible mounting position	any							
Degree of protection acc. to EN 60529	Terminals: IP20; Cover: IP40							
Rated insulation voltage U_i (pollution degree 3)	V	300						
Conductor cross-section								
• Screw-type connection								
- Solid	mm ²	1 x (0.5 ... 4)/2 x (0.5 ... 2.5)						
- Finely stranded, with end sleeve	mm ²	1 x (0.5 ... 2.5)/2 x (0.5 ... 1.5)						
- AWG conductors, solid or stranded	AWG	2 x (20 ... 14)						
- Tightening torque	Nm	0.8 ... 1.2						
• Spring-loaded terminal								
- Solid	mm ²	2 x (0.25 ... 1.5)						
- Finely stranded, with end sleeve	mm ²	2 x (0.25 ... 1)						
- Finely stranded, without end sleeve	mm ²	2 x (0.25 ... 1.5)						
- AWG conductors, solid or stranded	AWG	2 x (24 ... 16)						
- Corresponding opening tool	8WA2 807							
Vibration resistance acc. to IEC 68-2-6	Hz/mm	5 ... 26/0.75						
Shock resistance to IEC 68-2-27	g/ms	15/11						

1) 2-wire connection of resistance sensors with wire jumper between T2 and T3.

Monitoring Relays 3RS10, 3RS11 Temperature Monitoring Relays

Relays, analog adjustable

Dimensional drawings

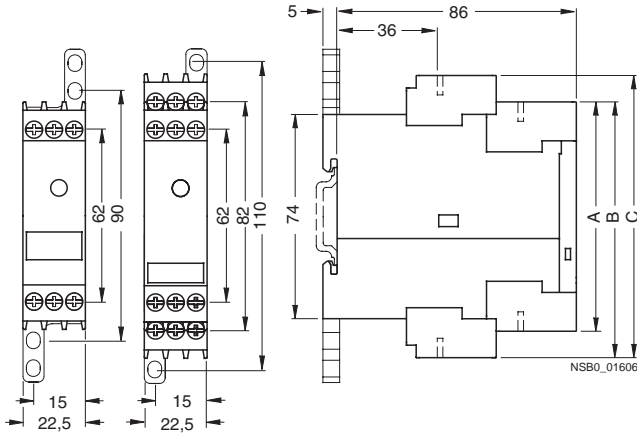

	A	B	C
Type	3RS10 00	3RS10 10	3RS11 0 3RS11 1 3RS1 .2 3RS1 .3
Standard terminal			
Screw-type terminal	80	90	100
Removable terminal			
Spring-loaded terminal	84	94	103
Screw-type terminal	83	92	102

Schematics

Connection examples

3RS10 00, 3RS10 10

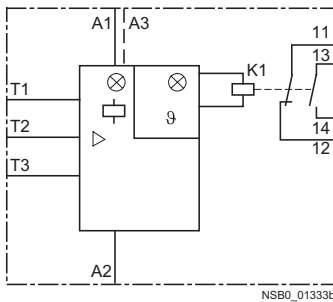

3RS11 00, 3RS11 01

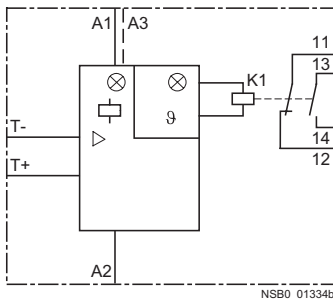

3RS10 20, 3RS10 30

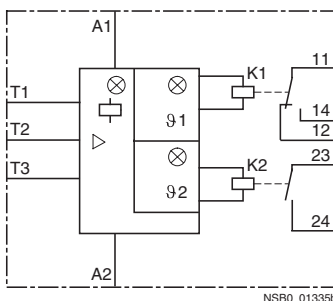

3RS11 20, 3RS11 21

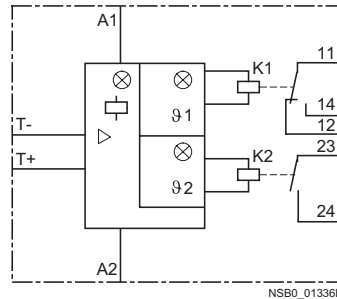

General equipment designation

A1 = 24 V AC/DC, 230 V AC, 24 ... 240 V AC/DC

A3 = 110 V AC

A2 = M

K1, K2, K3 output relay

Equipment designation for 3RS10 00, 3RS10 10, 3RS11 00, 3RS11 01, 3RS10 20, 3RS10 30, 3RS11 20, 3RS11 21

☐ = LED: "Device connected to supply"

91 = LED: "Relay 1 tripped"

92 = LED: "Relay 2 tripped"

T1 to T3 = Sensor connection for resistance sensor

T+/T- = Sensor connection for thermocouples

Caution!

When resistance sensors with two-wire connection are used, T2 and T3 must be jumpered.

Monitoring Relays

3RS10, 3RS11 Temperature Monitoring Relays

Relays, digitally adjustable to DIN 3440

Overview

The 3RS10/3RS11 temperature monitoring relays can be used for measuring temperatures in solid, liquid and gas media. The temperature is sensed by the sensor in the medium, evaluated by the device and monitored for overshoot or undershoot or for staying within an operating range (window function).

The 3RS10 40, 3RS20 40, 3RS11 40 and 3RS21 40 relays comply with the requirements of DIN 3440 as temperature monitors; the 3RS10 42 and 3RS11 42 relays comply with the requirements of DIN 3440 as temperature limiters. The relays are also an excellent alternative to temperature controls in the low-end performance range (2 or 3-point closed-loop control).

Technical specifications

Type	3RS10 40/3RS10 42/3RS20 40		3RS11 40/3RS21 40		3RS11 42	
General data						
Width	mm	45				
Operating range	V	0.85 ... 1.1 x U_s				
Rated power	W/VA	< 4/7				
Auxiliary circuits						
Contacts	1 CO + 1 CO + 1 NO					
Rated operational currents I_e						
• AC-15 at 230 V AC, 50 Hz	A	3				
• DC-13 at:						
- 24 V AC	A	1				
- 240 V AC	A	0.1				
DIAZED fuse	A	4				
gl/Gg operational class						
Electrical endurance	A	100000				
AC-15 at 3 A						
Mechanical endurance	30 x 10 ⁶					
Mechanical operating cycles						
Tripping units						
• Measuring accuracy at 20 °C ambient temperature (T20)	< ±2 K, ±1 digit		< ±5 K, ±1 digit		< ±7 K, ±1 digit	
• Reference point accuracy	--		< ±5 K			
• Deviations due to ambient temperature in % from measuring range	%	0.05 °C per K deviation from T20				
• Measuring cycle	ms	500				
• Hysteresis settings - for temperature 1	1 ... 99 Kelvin, for both values					
Adjustable delay time	s	0 ... 999				
Sensor circuits						
• Typical sensor circuits						
- PT100	mA	Typical 1	-	-	-	-
- PT1000/KTY83/KTY84/NTC	mA	Typical 0.2	-	-	-	-
• Open-circuit detection	Yes ¹⁾		Yes		Yes	
• Short-circuit detection	Yes		No		No	
• 3-wire conductor connection	Yes ²⁾		-		-	
Enclosures						
Environmental influences						
Permissible ambient temperature	°C	-25 ... +60				
Permissible storage temperature	°C	-40 ... +80				
Permissible mounting position	any					
Degree of protection acc. to EN 60529	Terminals: IP20; Cover: IP40					
Rated insulation voltage U_i (pollution degree 3)	V AC	300				
Conductor cross-section						
• Screw-type connection	M 3.5 (standard screwdriver, size 2 and Pozidriv 2)					
- Solid	mm ²	1 x (0.5 ... 4)/2 x (0.5 ... 2.5)				
- Finely stranded, with end sleeve	mm ²	1 x (0.5 ... 2.5)/2 x (0.5 ... 1.5)				
- AWG conductors, solid or stranded	AWG	2 x (20 ... 14)				
- Tightening torque	Nm	0.8 ... 1.2				
• Spring-loaded terminal						
- Solid	mm ²	2 x (0.25 ... 1.5)				
- Finely stranded, with end sleeve	mm ²	2 x (0.25 ... 1)				
- Finely stranded, without end sleeve	mm ²	2 x (0.25 ... 1.5)				
- AWG conductors, solid or stranded	AWG	2 x (24 ... 16)				
- Corresponding opening tool	8WA2 807 ³⁾					
Vibration resistance IEC 68-2-6	Hz/mm	5 ... 26/0.75				
Shock resistance IEC 68-2-27	g/ms	15/11				

1) Not for NTC B57227-K333-A1 (100 °C: 1.8 k; 25 °C: 32.762 k).

2) 2-wire connection of resistance sensors with wire jumper between T2 and T3.

3) See Catalog LV1, Accessories, 3RP15 Solid-State Timing Relays.

Monitoring Relays

3RS10, 3RS11 Temperature Monitoring Relays

Relays, digitally adjustable to DIN 3440

Dimensional drawings

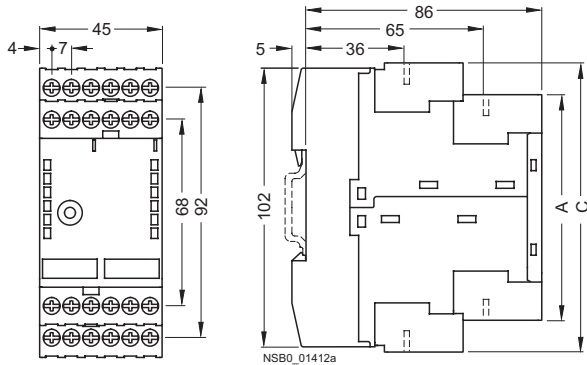

	A	C
3RS10, 3RS11, 3RS20, 3RS21 digital		
Removable terminal		
Spring-loaded terminal	84	108
Screw-type terminal	83	106

Schematics

Connection examples

3RS10 40, 3RS10 42, 3RS20 40

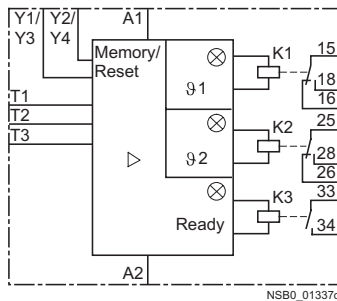

3RS11 40, 3RS11 42, 3RS21 40

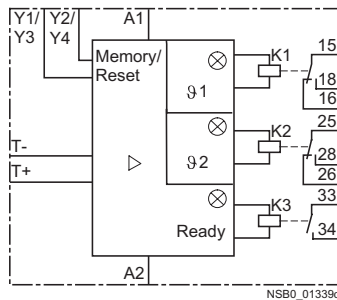

General equipment designation

A1, A2, A3 terminals for rated control supply voltage

K1, K2, K3 output relay

Item code

91 = LED: "Relay 1 tripped"

92 = LED: "Relay 2 tripped"

Ready = LED: "Device is ready for operation"

T1 to T3 = Sensor connection for resistance sensor

T+/T- = Sensor connection for thermocouples

Y1/Y2 connection for memory jumper for 3RS10 40, 3RS11 40, 3RS20 40, 3RS21 40 or Y3/Y4 Reset input for 3RS10 42, 3RS11 42

Caution!

When resistance sensors with two-wire connection are used, T2 and T3 must be jumpered.

Monitoring Relays

3RS10, 3RS11 Temperature Monitoring Relays

Relays, digitally adjustable for up to 3 sensors

Overview

The 3RS10 41 temperature monitoring relays can be used for measuring temperatures in solid, liquid and gas media. The temperature is sensed by the sensor in the medium, evaluated by the device and monitored for overshoot or undershoot or for

staying within an operating range (window function). The signal evaluator can evaluate up to 3 resistance sensors at the same time and is specially designed for monitoring motor windings and bearings.

Technical specifications

Type	3RS10 41	
General data		
Width	mm	45
Operating range	V	0.85 ... 1.1 x U_s
Rated power	W/VA	< 4/7
Auxiliary circuits		
Contacts	1 CO + 1 CO + 1 NO	
Rated operational currents I_e		
• AC-15 at 230 V AC, 50 Hz	A	3
• DC-13 at:		
- 24 V AC	A	1
- 240 V AC	A	0.1
DIAZED fuse		
• gl/Gg operational class	A	4
Electrical endurance AC-15 at 3 A	A	100000
Mechanical endurance Mechanical operating cycles		30 x 10 ⁶
Tripping units		
• Measuring accuracy at 20 °C ambient temperature (T20)		< ±2 K, ±1 digit
• Deviations due to ambient temperature in % from measuring range	%	0.05 per K deviation from T20
• Measuring cycle	ms	500
• Hysteresis settings for temperature 1		1 ... 99 K, for both values
• Adjustable delay time	s	0 ... 999
Sensor circuits		
• Typical sensor circuits		
- PT100	mA	Typical 1
- PT1000/KTY83/KTY84/NTC	mA	Typical 0.2
• Open-circuit detection		Yes ¹⁾
• Short-circuit detection		Yes
• 3-wire conductor connection		Yes ²⁾
Enclosures		
Environmental influences		
Permissible ambient temperature	°C	-25 ... +60
Permissible storage temperature	°C	-40 ... +80
Permissible mounting position		any
Degree of protection acc. to EN 60529		Terminals: IP20; Cover: IP40
Rated insulation voltage U_i (pollution degree 3)	V AC	300
Conductor cross-section		
• Screw-type connection		M 3.5 (standard screwdriver, size 2 and Pozidriv 2)
- Solid	mm ²	1 x (0.5 ... 4)/2 x (0.5 ... 2.5)
- Finely stranded, with end sleeve	mm ²	1 x (0.5 ... 2.5)/2 x (0.5 ... 1.5)
- AWG conductors, solid or stranded	AWG	2 x (20 ... 14)
- Tightening torque	Nm	0.8 ... 1.2
• Spring-loaded terminal		
- Solid	mm ²	2 x (0.25 ... 1.5)
- Finely stranded, with end sleeve	mm ²	2 x (0.25 ... 1)
- Finely stranded, without end sleeve	mm ²	2 x (0.25 ... 1.5)
- AWG conductors, solid or stranded	AWG	2 x (24 ... 16)
- Corresponding opening tool		8WA2 807 ³⁾
Vibration resistance IEC 68-2-6		5 ... 26 Hz/0.75 mm
Shock resistance IEC 68-2-27		15 g/11 ms

1) Not for NTC B57227-K333-A1 (100 °C: 1.8 k; 25 °C: 32.762 k).

2) 2-wire connection of resistance sensors with wire jumper between T2 and T3.

3) See Catalog LV1, Accessories, 3RP15 Solid-State Timing Relays.

Monitoring Relays 3RS10, 3RS11 Temperature Monitoring Relays

Relays, digitally adjustable for up to 3 sensors

Dimensional drawings

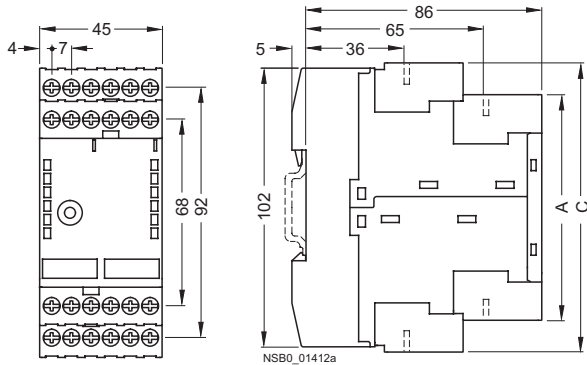

	A	C
3RS10, 3RS11, 3RS20, 3RS21 digital		
Removable terminal		
Spring-loaded terminal	84	108
Screw-type terminal	83	106

Schematics

Connection example

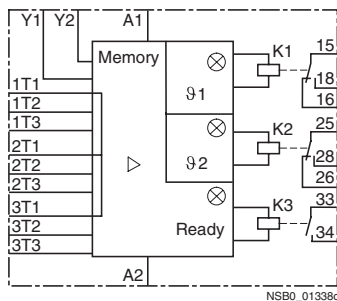

General equipment designation

A1, A2, A3 terminals for rated control supply voltage
K1, K2, K3 output relay

Equipment designation for 3RS10 41

91 = LED: "Relay 1 tripped"

92 = LED: "Relay 2 tripped"

Ready = LED: "Device is ready for operation"

1T1 to 1T3 = Sensor connection for resistance sensor 1

2T1 to 2T3 = Sensor connection for resistance sensor 2

3T1 to 3T3 = Sensor connection for resistance sensor 3

Y1/Y2 connection for memory jumper

Caution!

When resistance sensors with two-wire connection are used, T2 and T3 must be jumpered.

Monitoring Relays

3RN1 Thermistor Motor Protection

For PTC sensors

Overview

Thermistor motor protection devices are used for direct monitoring of the motor winding temperature. For this purpose, the motors are equipped with temperature-dependent resistors

(PTC) that are directly installed in the motor winding and abruptly change their resistance at their limit temperature.

Design

The 3RN1 tripping units are suitable for use in any climate and finger-safe according to EN 0106 Part 50274. They comply with:

- EN 61000-6-2 and EN 61000-6-4, "Electromagnetic compatibility of I&C equipment in industrial process engineering"
- EN 60947-8

The terminals of the auxiliary contacts are designated in accordance with EN 50005.

The 3RN1 tripping units are suitable for snap-on mounting onto 35 mm standard mounting rails according to EN 50022 or for screw-mounting using an adapter (Accessories).

Any mounting position is possible.

For devices with the "Manual RESET" function, the test function can be activated and a trip simulated by pressing the blue Test/RESET button for longer than 2 seconds.

If a Type A temperature sensor is connected to a Type A tripping unit, compliance with the operating temperatures is assured (on pick-up and reset) according to IEC 60034-11-2 (EN 60947-8).

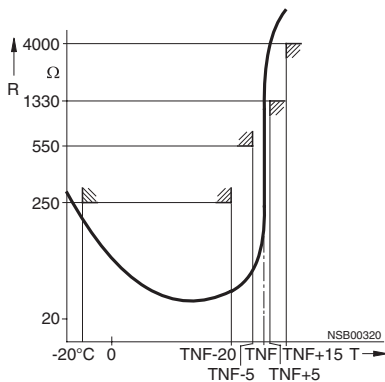

The characteristic curves of the Type A temperature sensors are described in EN 60947-8, DIN 44081 and DIN 44082.

Use in areas subject to explosion hazard for gases

All devices are approved for Equipment Group II, Category (2) in Area "G" (areas that contain explosive gases, vapor, spray and air mixtures).

With PTB 01 ATEX 3218 ex II (2) G, compliance with guideline 94/9 EG Appendix II is confirmed. The safety devices must be selected with suitable settings for the safe operation of motors of the "Increased safety" (EEx e) and "Flameproof enclosure" (EEx d) degrees of protection and are accessed outside the area subject to explosion hazard.

PTB 01 ATEX 3218 ex II (2) G

The increased danger in areas subject to explosion hazard demands careful analysis of the operator's guide, the safety and commissioning instructions and the standard (EN 60079-14/VDE 0165) for electronic equipment in areas subject to gas explosion hazards.

A risk analysis must be performed for the complete plant or machine. If this risk analysis results in a minimal potential for danger (Safety Category 1), all 3RN1 TMS tripping units can be implemented taking into account the safety notes. In the case of plants or machines with a high potential risk, variants with integrated short-circuit detection in the sensor circuit are necessary.

Use in areas subject to explosion hazard for dust

PTB 01 ATEX 3218 ex II (2) G

3RN10 11-B/-G, 3RN10 12-B/-G and 3RN10 13-...0 tripping units can be used as safety devices for motors in areas subject to gas explosion hazard for protection against impermissible overheating due to overload. If the ATEX marking has the extension "D:=Dust", these units can also be used as protective devices for motors in areas subject to dust explosion hazard (EN 50281-1-1).

Additional information is provided in the EU type test certificate which can be obtained from the Internet. The units comply with the requirements of the following classes:

Device	Class
3RN10 00, 3RN10 10, 3RN10 11-.C, 3RN10 12-.C, 3RN10 22, 3RN10 62	EN 954-1: Category 1
3RN10 11-.B, 3RN10 11-.G, 3RN10 12-.B, 3RN10 12-.G, 3RN10 13	EN 954-1: Category 2

The measuring circuit leads must be routed as separate control leads. It is not permitted to use cores from the supply line of the motor or any other main supply cables. If extreme inductive or capacitive interference is expected as a result of power lines routed in parallel, shielded control leads must be used.

Monitoring Relays 3RN1 Thermistor Motor Protection

For PTC sensors

Cable routing

Maximum cable length for sensor circuit cables

Conductor cross-section in mm ²	Cable length in m for tripping units	
	Without short-circuit detection 3RN10 00, 3RN10 10 3RN10 11-.C 3RN10 12-.C 3RN10 22, 3RN10 62	With short-circuit detection ¹⁾ 3RN10 11-.B/-G 3RN10 12-.B/-G 3RN10 13
2.5	2 x 2800	2 x 250
1.5	2 x 1500	2 x 150
0.5	2 x 500	2 x 50

1) A short-circuit in the sensor circuit will be detected up to this maximum cable length.

Notes:

Tripping of the thermistor protection relay even in combination with a converter must directly result in disconnection. This must be implemented with circuitry.

Mounting and installation must only be performed by qualified personnel who observe the applicable regulations! For mounting, use installation manual No.: 3ZX1012-0RN10-1AA1.

The 3RN10 is not intended for installation in hazardous areas. For installation in areas subject to explosion hazards, the 3RN10 must be enclosed in a flameproof casing.

For tripping units with a 24 V AC/DC control voltage, electrical isolation must be secured with a battery network or a safety transformer according to DIN VDE 0551.

When tripping units with Auto-RESET function are used, a reset is performed automatically after the cooling time has expired. It must be ensured by means of an external interlock (latching with a separate On and Off button) that the machine to be monitored does not start up again spontaneously.

Units with the Auto-RESET function must not be used in applications in which the unexpected restart can lead to personal injury or property damage.

In the case of tripping units without short-circuit detection, during commissioning or after modifications or maintenance work (assembly, disassembly) on the equipment, the sensor resistance must be measured using a suitable measuring instrument. For resistances < 50 Ohm, the sensor circuit must be checked for a short-circuit.

If 3RN10 00 units are used to protect EEx e motors, separate monitoring of the control voltage is recommended because there is no Ready LED to indicate connection to the supply voltage.

If 3RN10 13-.BW01 units are used to protect EEx e motors, separate monitoring of the control voltage is recommended because the switching status of the auxiliary contacts does not change if the control voltage fails (use of a bistable relay is recommended).

Before commissioning, the effectiveness of the protection function must be checked.

Function

The 3RN1 tripping units operate in accordance with the closed-circuit principle and therefore monitor themselves for open-circuit (except: warning output in the case of 3RN10 22). A momentary power failure of less than 50 ms does not change the status of the auxiliary contacts. The 3RN10 11, 3RN10 12 and 3RN10 13 units with 2 changeover contacts are also equipped with short-circuit detection in the sensor circuit. The unit will trip in the event of a short-circuit in the sensor circuit (resistance in sensor circuit < 20 Ω).

All tripping units (except for 24 V AC/DC) feature electrical isolation between the control circuit and the sensor circuit.

3RN10 00 compact tripping units

The compact tripping unit is equipped with a red LED (TRIPPED) for the tripped display and a changeover contact.

After the unit has tripped, it is automatically reset once the thermistors have cooled down. The root of the changeover contact is connected to the control voltage (95 is connected to terminal A1).

This unit is particularly suitable in circuits in which the control circuit and signaling circuit have the same potential, e.g. in local control boxes.

3RN10 10, 3RN10 11, 3RN10 12, 3RN10 13 standard tripping units

The standard units are equipped with two LEDs (READY and TRIPPED) for an operating and tripped display and are available with either 1 NO + 1 NC or with 2 CO contacts. They are available depending on the version with automatic RESET (3RN10 10), manual/remote RESET (3RN10 11) or manual/automatic and remote RESET (3RN10 12 and 3RN10 13). Remote RESET can be achieved by connecting an external pushbutton with a normally-open function to terminals Y1 and Y2. If terminals Y1 and Y2 are bridged, tripping will be followed by an automatic RESET.

The 3RN10 11, 3RN10 12 and 3RN10 13 units with 2 COs also have short-circuit monitoring in the sensor circuit.

The 3RN10 12 and the 3RN10 13 are non-volatile. This means that even if the control voltage fails, a preceding trip will be latched.

In the case of the 3RN10 13 tripping unit, tripping due to a short-circuit in the sensor circuit will be indicated by a flashing red LED. The monostable version also indicates open-circuit in the sensor circuit by flashing of the red LED.

3RN10 22 "Warning and disconnection" tripping units

Two sensor circuits can be connected to one 3RN10 22 tripping unit that acts on one output relay with 1 NO contact for warning and 1 CO for disconnection. Temperature sensors with different rated response temperatures TNF are used to implement the "Warning" and "Disconnection" functions. When the "Warning" sensor circuit responds, a yellow LED is lit and when the "Disconnection" circuit responds, a red LED is lit.

The sensor circuits have a different reset response and operating behavior:

- "Warning" (terminals 2T1, T2) only features automatic RESET and uses the open-circuit principle.
- "Disconnection" (terminals 1T1, T2) can be changed from manual RESET to automatic RESET by linking terminals Y1 and Y2. Remote RESET is implemented by connecting an external pushbutton with a normally-open function.

Monitoring Relays

3RN1 Thermistor Motor Protection

For PTC sensors

3RN10 62 tripping units for multiple motor protection

Up to 6 sensor circuits can be connected to the 3RN10 62 tripping unit, all of which act on one output relay. The simultaneous protection of several motors (up to 6) is an advantage for multi-motor drives (e.g. if one motor is overloaded, all the other motors of the drive will be shut down). Apart from the red LED TRIPPED, which signals the switching status of the tripping unit, an LED is assigned to each sensor circuit which indicates the sensor circuit that has responded. Unused sensor circuits must be short-circuited.

The reset response of the 3RN10 62 tripping units can be changed from manual RESET to automatic RESET by linking terminals Y1 and Y2. Remote RESET is implemented by connecting an external pushbutton with a normally-open function.

Response of the tripping units in the event of control voltage failure

Behavior for	Monostable	Non-volatile Monostable	Bistable
	3RN10 00 3RN10 10 3RN10 11	3RN10 12 3RN10 13-...0 3RN10 22 3RN10 62	3RN10 13-...01
Failure of the control voltage	Device trips	Device trips	No change in state of the auxiliary contacts
Return of the control voltage without a preceding tripping operation	Device resets	Device resets	No change in state of the auxiliary contacts
Return of the control voltage after a preceding tripping operation	Device resets	The device remains tripped	No change in state of the auxiliary contacts

Safe electrical isolation

All circuits (outputs, control circuits, sensor and RESET circuits) of the multifunction tripping units 3RN10 13-1BW10 and 3RN10 13-1GW10 (wide voltage range, monostable output relay and screw-type terminals) are safely isolated from each other up to a rated voltage of 300 V according to DIN VDE 0100 Part 410/EN 60947-1.

Function diagrams

3RN10 00/3RN10 10 (Auto-RESET)

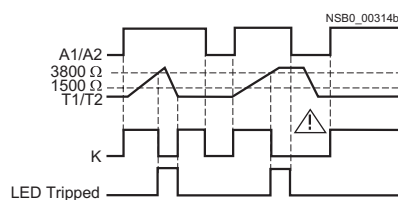

3RN10 11¹⁾

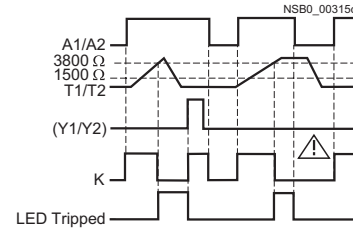

3RN10 13-...01

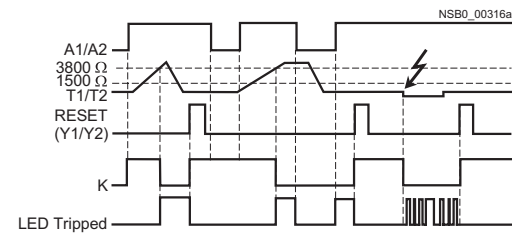

3RN10 12¹⁾/3RN10 22/3RN10 62

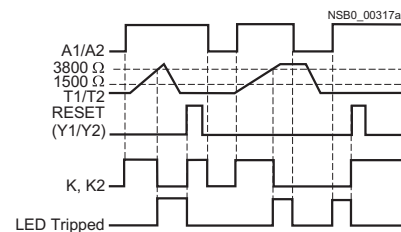

3RN10 13-...0

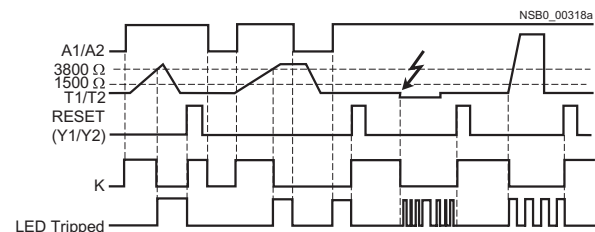

3RN10 22 only

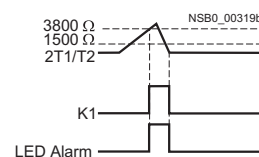

1) For versions with 2 CO (3RN10 1.G...): See 3RN10 13. function diagram for short-circuit response of sensor circuit.

Monitoring Relays 3RN1 Thermistor Motor Protection

For PTC sensors

Technical specifications

Type	Compact units				Standard units		Multifunction units	Warning + tripping	Multiple motor protection	
	3RN10 00	3RN10 10	3RN10 11	3RN10 12	3RN10 13	3RN10 22				3RN10 62
General data										
Width	mm	22.5								45
Number of connectable sensor circuits		1						2		6
Response in the event of control voltage failure		1)								
Manual RESET		No			Yes					
Automatic RESET		Yes			No	Yes				
Remote RESET		No			Yes ²⁾	Yes				
TEST pushbutton		No			Yes					
Short-circuit detection for sensor circuit		No			Yes (for 2 CO units)		Yes	No		
Short-circuit and open-circuit indication		No					Yes ³⁾	No		
Warning and switching off in one unit		No						Yes	No	
Tripping units										
Rated insulation voltage U_i (pollution degree 3)	V	300								
Permissible ambient temperature	°C	-25 ... +60								
Permissible storage temperature	°C	-40 ... +80								
EMC tests		EN 61000-6-2, EN 61000-6-4								
Degree of protection acc. to EN 60529/VDE 0470-1		IP20								
Conductor cross-section										
Screw-type connection		M3								
• Solid	mm ²	1 x (0.5 ... 4)/2 x (0.5 ... 2.5)								
• Finely stranded, with end sleeve	mm ²	1 x (0.5 ... 2.5)/2 x (0.5 ... 1.5)								
• AWG conductors, solid or stranded	AWG	2 x (20 ... 14)								
• Tightening torque	Nm	0.8 ... 1.2								
Spring-loaded terminals										
• Solid	mm ²	2 x (0.25 ... 1.5)								
• Finely stranded, with end sleeve	mm ²	2 x (0.25 ... 1.5)								
• Finely stranded, without end sleeve	mm ²	2 x (0.25 ... 1.5)								
• AWG conductors, solid or stranded	AWG	2 x (24 ... 16)								
Sensor circuits										
Measuring circuit load at $R_F \leq 1.5 \text{ mW}$		≤ 5								
Voltage in sensor circuit at $R_F \leq 1.5 \text{ mW}$	V	≤ 2								
Response temperature (depends on sensor)	°C	60 ... 180								
Coupling time (depends on sensor)	s	Approx. 5								
Summation PTC resistance R_F (per sensor loop)	k Ω	≤ 1.5								
• Operating value	k Ω	3.4 ... 3.8								
• Return value	k Ω	1.5 ... 1.65								
• Response tolerance	°C	± 6								

- 1) See Catalog LV 1, Selection and Ordering Data.
- 2) Remote RESET possible by disconnecting control voltage.
- 3) Open-circuits are only indicated by monostable versions (3RN10 13-....0).
- 4) See Catalog LV1, Accessories, 3RP15 Solid-State Timing Relays.

Monitoring Relays

3RN1 Thermistor Motor Protection

For PTC sensors

Type	Compact units				Standard units		Multifunction units	Warning + tripping	Multiple motor protection	
	3RN10 00	3RN10 10	3RN10 11	3RN10 12	3RN10 13	3RN10 22	3RN10 62			
Control circuits										
Rated control supply voltage U_s	1)									
Operating range 110 V/230 V AC • 24 V ... 240 V AC/DC • 24 V AC/DC	0.85 ... 1.1 x U_s 0.85 ... 1.1 x U_s 0.85 ... 1.2 x U_s for DC operation, 0.85 ... 1.1 x U_s for AC operation									
Rated power • AC • AC/DC • DC	W	< 2								
Max. mains buffering time	ms	50								
Auxiliary circuits										
Continuous thermal current I_{the}	A	5								
Rated operational current I_e • AC-15 240 V • DC-13 24 V	A	3				1 for units with 1 CO or 2 COs 2 for units with 1 NC + 1 NO		1 ²⁾	1	2
DIAZED fuse	A	6 ³⁾								
CSA and UL rated data, control circuit										
Rated control voltage 50/60 Hz • AC • DC	V	300								
Switching capacity		R 300/B 300								
Safe isolation up to 300 V acc. to DIN 60 947-1		--				3RN10 13-1BW10		--		

1) See Catalog LV 1, Selection and Ordering Data.

2) 2 A for 3RN10 13-BW01 (bistable output relays).

3) $I_n > 1$ kA weld-free acc. to EN 60947-5-1.

Dimensional drawings

3RN1. with 1 ... 2 sensor circuits

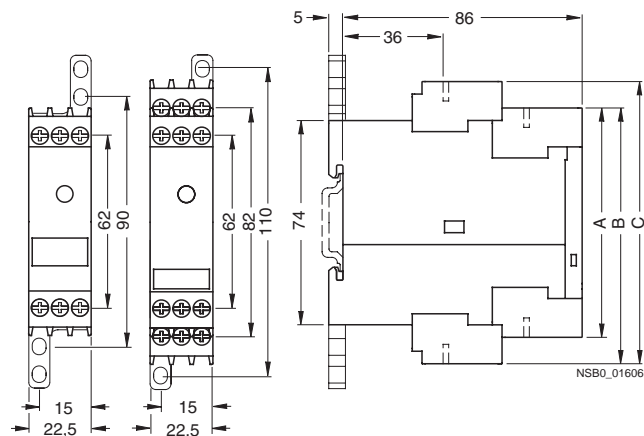

3RN10 62

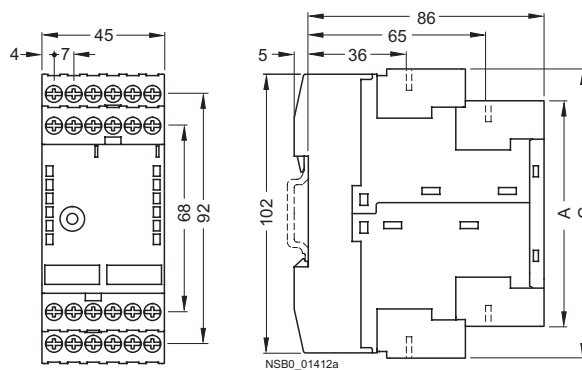

	A	B	C
	3RN10 00	3RN10 00	3RN10 11 3RN10 12 3RN10 13 3RN10 22
Removable terminal			
Spring-loaded terminal	84	94	103
Screw-type terminal	83	92	102

	A	C
	3RN10 62	
Standard terminal		
Spring-loaded terminal	84.3	107.6
Screw-type terminal	81	104
Removable terminal		
Spring-loaded terminal	84	108
Screw-type terminal	83	106

Monitoring Relays 3RN1 Thermistor Motor Protection

For PTC sensors

Schematics

Connection diagrams

Illustrated with control voltage applied

Illustrated with control voltage not applied

Illustrated with control voltage applied

Illustrated with control voltage not applied

General equipment designation

3RN10 00, 1 CO

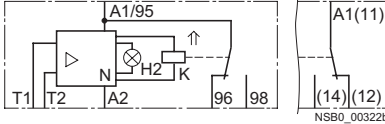

3RN10 10, 1 NO + 1 NC

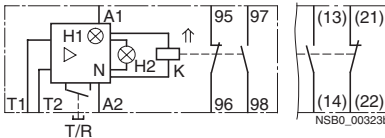

3RN10 10, 2 COs

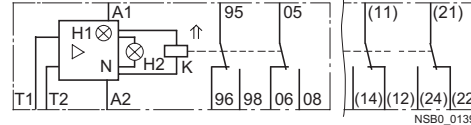

3RN10 11¹⁾, 1 NO + 1 NC

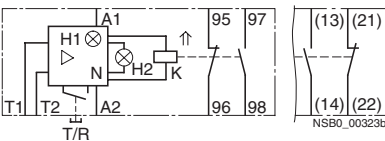

3RN10 11, 2 COs

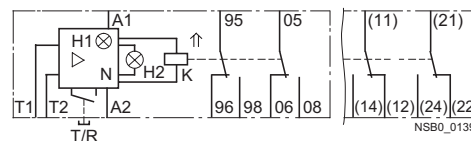

3RN10 12¹⁾, 1 NO + 1 NC

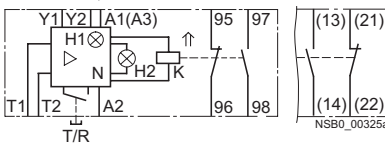

3RN10 12, 2 COs

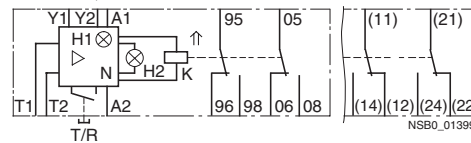

3RN10 13-...0 (monostable)

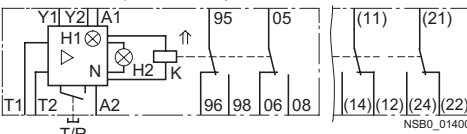

3RN10 13-...1 (bistable)

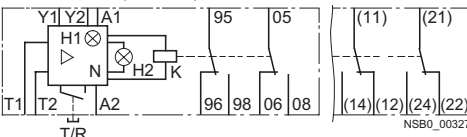

3RN10 22

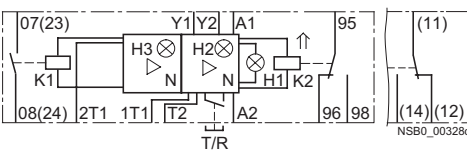

3RN10 62

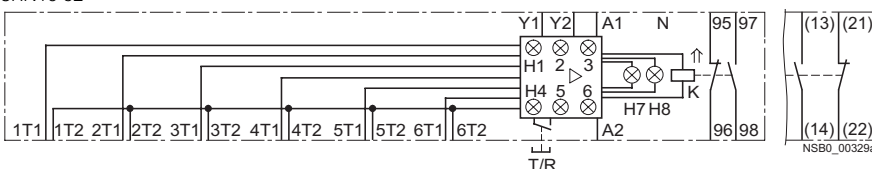

A1, A2, A3 Connections of the control voltage
N Amplifier
T/R TEST/RESET button
Y1, Y2 Connections for remote RESET (jumpered = Auto-RESET)
↑ The double arrow indicates an operating status which deviates from the standard representation of the contact acc. to DIN 40900, Part 7 (in this case: Position of the contacts when control voltage is applied to terminals A1 and A2)

Equipment designation for 3RN10

H1 "READY" LED
H2 "TRIPPED" LED
K Output relay
T1, T2 Connections of the sensor loop

Equipment designation for 3RN10 22

H1 "READY" LED
H2 "TRIPPED" LED
H3 "ALARM" LED
K1, K2 Output relay
1T1 and T2 Connections of the first sensor loop
2T1 and T2 Connections of the second sensor loop

⚠ Important!

Close unconnected sensor circuits.

Equipment designation for 3RN10 62

H1 to H6 LED for the tripped sensor loop
H7 "READY" LED
H8 "TRIPPED" LED
K Output relay
1T1, 1T2 Connections of the first sensor loop
6T1, 6T2 Connections of the sixth sensor loop

⚠ Important!

Close unconnected sensor circuits.

1) For units with combination voltages 230 V/110 V AC (3RN10 11-CK00 and 3RN10 12-CK00) the following applies:
A1 and A2: 230 V AC,
A3 and A2: 110 V AC.

3TK28 Safety Relays

With electronic enabling circuits

Overview

The SIRIUS safety pilot guides you quickly to the right device

Type	Connection		Crossover protection	Category acc. to EN 954-1					EMERGENCY-STOP	Protective door	Solid-state sensors	Cascading input 24 V DC	Safety mats
	1-channel	2-channel		B	1	2	3	4					
3TK28 40 basic unit	✓	✓	✓	✓	✓	✓	✓	✓	✓	✓	--	--	--
3TK28 41 standard unit	✓	✓	✓	✓	✓	✓	✓	✓	✓	✓	✓	1	✓
3TK28 42 standard unit tv	✓	✓	✓	✓	✓	✓	✓	✓	✓	✓	✓	1	✓
3TK28 45 multi-function unit	✓	✓	✓	✓	✓	✓	✓	✓	✓	✓	✓	1	✓

Type	Enabling circuit, floating		Enabling circuit, solid-state		Signal-ing circuit	Autostart	Moni-tored start	Switching capacity		Rated operational voltage			Rated control supply voltage			Control inputs
	Stop category 0	Stop category 1	Stop category 0	Stop category 1				AC-15 at U=230 V	DC-13 at U=24 V	24 V DC	230 V AC	600 V AC	24 V DC	115 V AC	230 V AC	
3TK28 40 basic unit	--	--	2 ¹⁾	--	--	✓	✓	--	0.5 A	✓	--	--	✓	--	--	--
3TK28 41 standard unit	--	--	2	--	--	✓	✓	--	1.5 A	✓	--	--	✓	--	--	--
3TK28 42 standard unit tv	--	--	1	1	--	✓	✓	--	1.5 A	✓	--	--	✓	--	--	--
3TK28 45 multi-function unit	1	1	1	1	1 HL	✓	✓	2 A	1.5 A	✓	✓	--	✓	--	--	--

✓ = available
-- = not available

1) The outputs are only safe when an external contactor is used.

Design

The solid-state safety relays can be used in EMERGENCY-STOP devices to EN 418 and in safety circuits to EN 60204-1 (11.98), for example, for moving covers and protective doors. Depending on the device type and the external circuit, the maximum category that can be achieved is Category 4 of EN 954-1 or SIL 3 according to IEC 61508.

Installation

For snap-on mounting on 35 mm standard mounting rail according to EN 50022. Screw fixing is also possible for the devices by means of 2 additional 3RP19 03 push-in lugs.

Function

The electronics (based on the example of a 3TK28 41)

- The internal circuit is configured with redundancy and diversity. The processors monitor each other dynamically.
- The output drivers are also redundant and diverse. They are monitored by a cyclic self-test.
- All sensor signals are dynamically tested. This enables faults to be detected on the sensors, wires (cross-circuit) etc.
- The field-effect transistor (FET) is switched by both processors. The output driver must be activated simultaneously by one of the two processors. Only then is the voltage connected safely from power supply terminal A1 to output terminals 14 + 24.
- All solid-state switches (FET + output driver) are dynamically monitored by the processors.
- The required functionality (1-channel or 2-channel), monitored start or autostart, EMERGENCY-STOP, protective door and cascading is set by means of jumpers at the connection terminals.

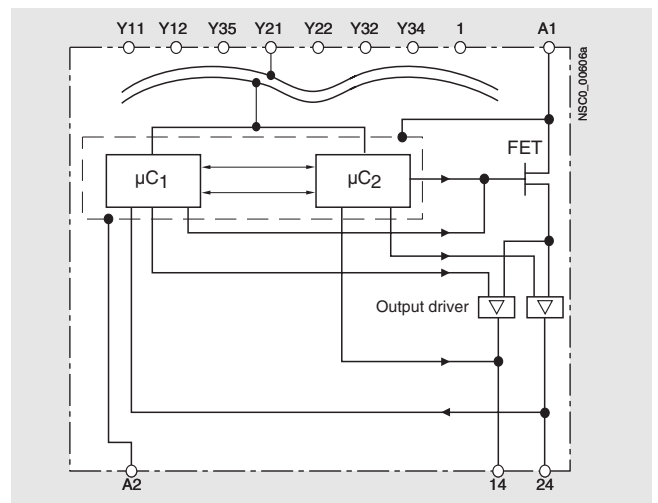

Technical specifications

Type		3TK28 40	3TK28 41	3TK28 42	3TK28 45
Standards		EN 60204-1 (VDE 0113 Part 1), EN ISO 12100, EN 954-1, IEC 61508, DIN VDE 0116 ¹⁾			
Category acc. to EN 954-1		3	4	4	4
Test certificates		TÜV, UL, CSA			
Rated insulation voltage U_i					
• For control circuit	V	50	50	50	50
• For outputs	V	50	50	50	50/300
Rated impulse withstand voltage U_{imp}					
• For control circuit	V	500	500	500	500
• For outputs	V	500	500	500	500/2000
Operating range					
• DC operation		0.9 ... 1.15 × U_s			
Rated operational currents I_e acc. to IEC 60947-5-1					
• $I_e/AC-15$	at 115 V A	--	--	--	2
	at 230 V A	--	--	--	--
• $I_e/DC-13$	at 24 V A	0.5	1.5	1.5	1.5
Short-circuit protection		Short-circuit proof			Short-circuit proof ²⁾
Electrical endurance		Unlimited, because switched electronically			
Operating frequency z in operating cycles/h during normal duty	1/h	3000			
Response time					
• Monitored start	ms	125	60	60	60
• Autostart	ms	250	60	60	60
release time					
• For EMERGENCY-STOP	ms	30	45	45 ³⁾ /0.05 ... 300 s (adjustable)	45 ³⁾ /0.05 ... 300 s (adjustable)
• For supply failure	ms	25	100 ⁴⁾	100 ⁴⁾	100
Recovery time					
• For EMERGENCY-STOP	ms	20	400	400	400
• For supply failure	s	0.02	max. 7	max. 7	max. 7
Bridging of supply failures	ms	25 ⁵⁾	25 ⁴⁾⁵⁾	25 ⁴⁾⁵⁾	25 ⁵⁾
Minimum command duration					
• EMERGENCY-STOP	ms	20	25	30	30
• ON button	s	0.02	0.2 ... 5	0.2 ... 5	0.2 ... 5
Simultaneity	ms	∞			
Conductor cross-sections					
Screw-type connection					
• Finely stranded with end sleeve	mm ²	2 × (0.5 ... 1.5), 1 × (0.5 ... 2.5)			
• Solid	mm ²	2 × (0.5 ... 2.5), 1 × (0.5 ... 4)			
• Tightening torque	Nm	0.8 ... 1.2			
Spring-loaded terminals		(1 or 2 conductors can be connected)			
• Solid	mm ²	2 × (0.25 ... 1.5)			
• Finely stranded with end sleeve	mm ²	2 × (0.25 ... 1.0)			
• Finely stranded without end sleeve	mm ²	2 × (0.25 ... 1.5)			
• AWG conductors, solid or stranded		2 × AWG 24 ... 16			
Permissible ambient temperature					
• During operation	°C	-25 ... +60			
• During storage	°C	-40 ... +80			
Degree of protection acc. to EN 60529					
• Enclosures		IP40			
• Terminals		IP20			
Touch protection acc. to DIN VDE 0106 Part 100		Finger-safe			
Shock resistance					
• Sinewave	g/ms	8/10 and 15/5			
Permissible mounting position		Any			

- 1) Electrical equipment for furnaces.
VDE certificate for 3TK28 41 and 3TK28 42 is available.
- 2) For relay outputs, use a fuse link:
LV HRC Type 3NA, DIAZED Type 5SB, NEOZED Type 5SE:
6 A (weld-free protection at $I_K = 1$ kA).
- 3) For instantaneous output.
- 4) When the cascading input is supplied from A1, the maximum response time is applicable to an external EMERGENCY-STOP.
- 5) The drivers are not supplied, internal supply bridging only.
SELV/PELV power supply unit buffered.



3TK28 Safety Relays

With electronic enabling circuits

Dimensional drawings

3TK28 with screw-type terminals

3TK28 40 to 3TK28 42

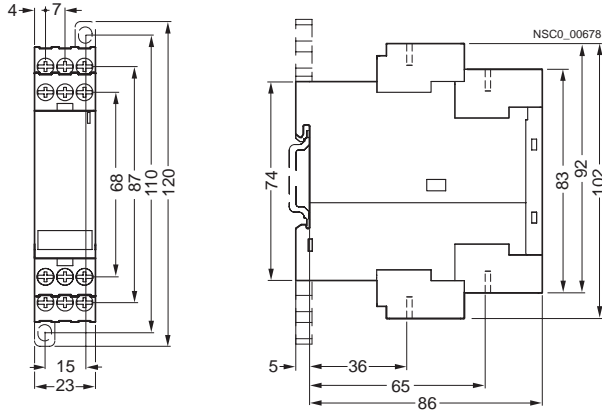

3TK28 with spring-loaded terminals

3TK28 40 to 3TK28 42

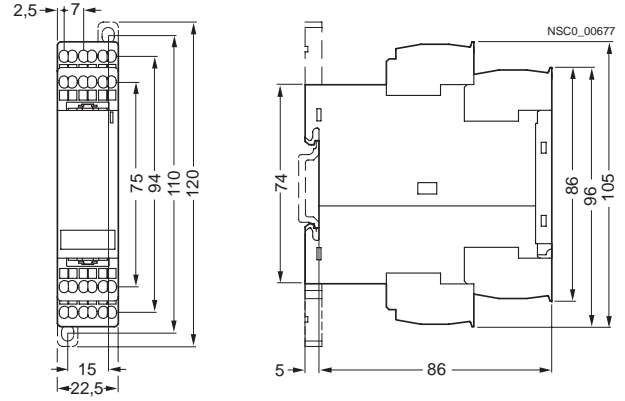

3TK28 45

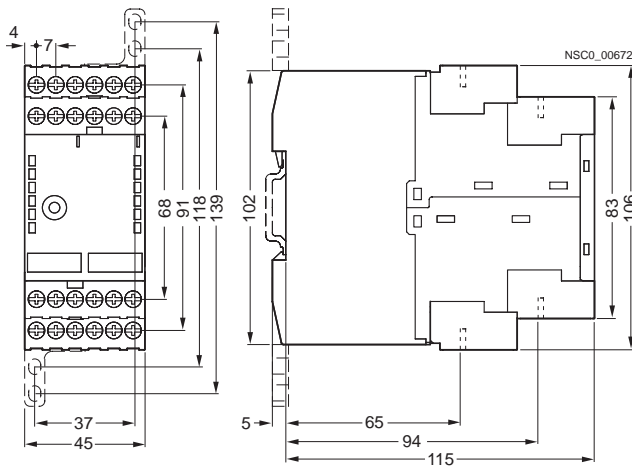

3TK28 45

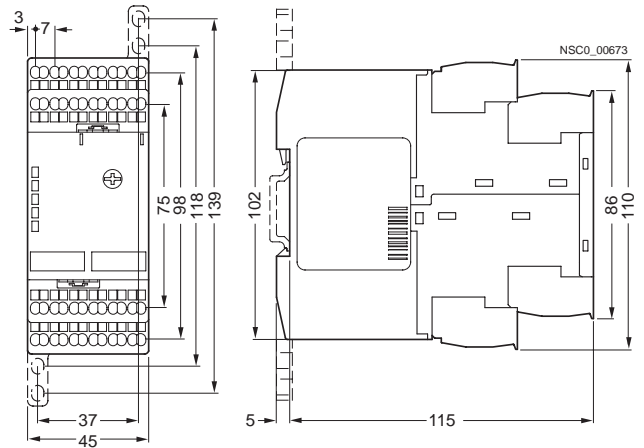

1) For 35 mm standard mounting rail acc. to EN 50002.

Overview

The SIRIUS safety pilot guides you quickly to the right device

Type	1-channel connection	2-channel connection	Crossover protection	Category acc. to EN 954-1				EMERGENCY-STOP	Protective door	Enabling contacts	Signaling contacts	Autostart	Monitored start
				B	1	2	3						
Basic units													
3TK28 21	✓	✓	✓	✓	✓	✓	✓	✓	✓	3 NO	1 NC	✓	--
3TK28 22	--	✓	✓	✓	✓	✓	✓	✓ ²⁾	✓	2 NO	--	✓	--
3TK28 23	--	✓	✓	✓	✓	✓	✓	✓	--	2 NO	--	--	✓
3TK28 24	✓	✓	✓	✓	✓	✓	✓	✓	✓	2 NO	--	✓	--
3TK28 25	✓	✓	✓	✓	✓	✓	✓	✓	✓	3 NO	2 NC	✓	✓
3TK28 27	✓	✓	✓	✓	✓	✓	✓ ¹⁾	✓	--	2 NO + 2 NO, delayed	1 NC	--	✓
3TK28 28	✓	✓	✓	✓	✓	✓	✓ ¹⁾	✓	✓	2 NO + 2 NO, delayed	1 NC	✓	--
Expansion devices (category as for basic unit)													
3TK28 30	--	--	●	●	●	●	●	--	--	4 NO	--	--	--
Press control devices (acc. to EN 574)													
3TK28 34	--	✓	✓	✓	✓	✓	✓	--	--	2 NO + 2 NC	--	--	--
3TK28 35	--	--	--	✓	✓	✓	✓	--	--	3 NO + 1 NC	--	--	--

✓ = available

-- = not available

● = corresponds to basic unit

1) Only possible for instantaneous enabling contacts.

2) The ON button is not monitored.

Design

The 3TK28 21 to 28, 3TK28 30 and 3TK28 34 safety relays operate with internal contactor relays with positively-driven contacts. The contacts of the controls comply with the requirement for positively driven operation laid down in ZH 1/457, Edition 2, 1978. NO and NC contacts are not allowed to be closed at the same time.

In a redundant circuit, operation of the internal controls is monitored. If a safety relay fails, it will always switch to the de-energized and consequently safe state. The fault is detected and the safety relay can no longer be switched on. The use of NO and NC contacts for the same function satisfies the demand for diversity.

This product series is characterized by its space-saving width (22.5 mm or 45 mm). The usual BIA, BG and SUVA approvals and test certificates have been awarded.

Enabling contacts (FK)

Safety related operation must be performed by safe output contacts, known as enabling contacts. Enabling contacts are always NO contacts and switch without delay.

Signaling contacts (MK)

NC contacts are used as signaling contacts but they are not permitted to perform functions with relevance for safety. An enabling contact can also be used as a signaling contact. A signaling contact cannot, however, be used as an enabling contact.

Delayed enabling contacts

Machine drives that overrun for a long time must be externally braked in the event of danger. For this purpose, the power supply for electrical braking can be maintained (Stop Category 1 according to EN 60204-1).

The basic units have off-delay enabling contacts in addition to instantaneous enabling contacts. Time delays of between 0.5 and 30 s are available with the different versions. A 3RP19 02 sealable covering cap (see Catalog LV 1, Selection and ordering data, Accessories) can be fitted to protect against unauthorized adjustment of the set delay time.

Expansion units

If the enabling contacts of the basic unit are inadequate, expansion units can be used. An expansion unit has 4 enabling contacts.

Expansion units are not allowed to be operated separately in safety-related switching circuits; they must be combined with a basic unit. One enabling contact of the basic unit is required for connecting an expansion unit. The category of a control system with expansion unit corresponds to that of the basic unit.

Installation

The equipment is designed for snap-on mounting on a 35 mm standard mounting rail to EN 50022. Screw fixing is also possible for the devices by means of 2 additional 3RP19 03 push-in lugs.

3TK28 Safety Relays

With relay enabling circuits

Technical specifications

Type		3TK28 21	3TK28 22	3TK28 23	3TK28 24	3TK28 30	3TK28 25	3TK28 27, 3TK28 28	3TK28 34	3TK28 35	
Standards		EN 60204-1 (VDE 0113 Part 1), EN ISO 12100, EN 954-1							Also EN 574		
Test certificates		BG, SUVA, UL, CSA									
Category		3	4	4	3	As basic unit	4	4 ¹⁾	4	As basic unit	
• Acc. to EN 954-1		--	--	--	--		--	--	Type III C		
• Acc. to EN 574											
Rated insulation voltage U_i	V	300									
Degree of pollution		3									
Overvoltage category acc. to EN 60664		III									
Rated impulse withstand voltage U_{imp}	kV	4									
Rated power of coils								3	4	3	
DC/AC operation at $1.0 \times U_s$	W	1.5									
Operating range of the coils											
• AC operation		0.85 ... $1.1 \times U_s$						0.85 ... $1.1 \times U_s$			
• DC operation		0.85 ... $1.2 \times U_s$						0.85 ... $1.1 \times U_s$			
Continuous thermal current I_{th}	A	5						6	5	6	5
Continuous thermal current I_{th}		2 FK		3 FK		4 FK					
for 2 to 4 enabling contacts (FK)											
• At AT 70 °C	A	4		3.5		3		5	4	5	4
• At AT 60 °C	A	4.5		4		3.5		6	5	6	5
• At AT 50 °C	A	5		4.5		4		6	5	6	5
Rated operational currents I_e											
acc. to IEC 60947-1											
• I_e /AC-15	at 115 V	A	5				6		5/2 ⁴⁾		6
	at 230 V	A	5				6		5/2 ⁴⁾		6
							6		5/2 ⁴⁾		6
• I_e /DC-13	at 24 V	A	5				6		5/2 ⁴⁾		6
											5/2 ⁵⁾
											5/2 ⁵⁾
Short-circuit protection		Fuse inserts LV HRC Type 3NA, DIAZED Type 5SB, NEOZED Type 5SE: 6 A									
(weld-free protection at $I_k = 1 \text{ kA}$) ³⁾		g/L/gG operational class 6 A (slow), quick 10 A ²⁾									
Mechanical endurance		10 million operating cycles									
Electrical endurance at I_e		100000 operating cycles									
Switching frequency		1000/h on loading with I_e									
Response time	ms							≤ 30 ⁸⁾		≤ 100	≤ 50
• Monitored start	ms	--	--	≤ 30	--	--	≤ 25	≤ 80	--	--	
• Autostart	ms	≤ 200 ⁶⁾	≤ 100	--	≤ 200 ⁶⁾⁷⁾	--	≤ 150	≤ 80	--	--	
Release time	ms							≤ 20		≤ 50	
• For EMERGENCY-STOP	ms	≤ 200	≤ 80	≤ 20	≤ 200	--	≤ 25	≤ 25	--	--	
• For supply failure	ms	≤ 200	≤ 100	≤ 150	≤ 200	≤ 25 ⁹⁾	≤ 350	≤ 100	--	--	
Recovery time								≥ 250		≥ 250	
• For EMERGENCY-STOP	ms	≥ 200	≥ 200	≥ 400	≥ 200	--	≥ 200	After time has elapsed $\geq 1 \text{ s}$	--	--	
• For supply failure	ms	≥ 200	≥ 200	≥ 600	≥ 200	≥ 100	≥ 500	$\geq 1 \text{ s}$	--	--	
Bridging of supply failures	ms	60	30	80	60	35	100	30	40	40	
Minimum command duration											
• EMERGENCY-STOP	ms	≥ 200	≥ 25	≥ 25	≥ 200 ⁷⁾	--	≥ 25	≥ 25	--	--	
• ON button	ms	≥ 150	≥ 40	≥ 25	≥ 150 ⁷⁾	--	≥ 25	≥ 25	--	--	
Simultaneity	ms	∞							500		
Conductor cross-sections											
Screw-type connection											
• Finely stranded with end sleeve	mm ²	2 × (0.5 ... 1.5), 1 × (0.5 ... 2.5)									
• Solid	mm ²	2 × (0.5 ... 2.5), 1 × (0.5 ... 4)									
• Tightening torque, M 3.5 screw	Nm	0.8 ... 1.2									
Spring-loaded terminals		(1 or 2 conductors can be connected)									
• Solid	mm ²	2 × (0.25 ... 1.5)									
• Finely stranded with end sleeve	mm ²	2 × (0.25 ... 1.0)									
• Finely stranded without end sleeve	mm ²	2 × (0.25 ... 1.5)									
• AWG conductors, solid or stranded		2 × AWG 24 ... 16									
Permissible ambient temperature											
• During operation	°C	$-25 \dots +60$ (suitable for butt-mounting; 70 °C possible with restrictions)									
• During storage	°C	$-40 \dots +80$									
Degree of protection acc. to EN 60529		IP40						IP20			
• Enclosures		IP20						IP20			
• Terminals											
Touch protection acc. to VDE 0106		Finger-safe									
Shock resistance , half-sine acc. to IEC 60068		8 g/10 ms									
Permissible mounting position		Any									

1) Only applicable for instantaneous enabling contacts; Category 3 applies for time-delayed contacts.

2) Signaling circuit for 3TK28 21 = 6 A.

3) Other fuses on request.

4) Instantaneous/time-delayed enabling contacts.

5) 2 A applies to enabling contacts 13/14.

6) At 24 V AC: 300 ms.

7) At 115, 230 V AC: 300 ms.

8) At 115, 230 V AC: max. 200 ms.

9) At 115, 230 V AC: max. 80 ms.

Dimensional drawings

3TK28 (relay type) with screw terminals

3TK28 21 to 3TK28 24, 3TK28 30

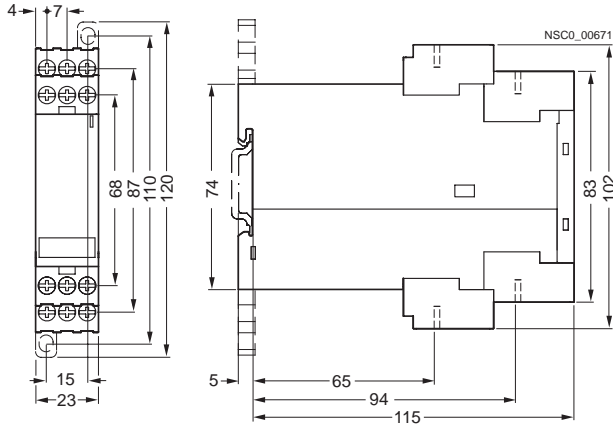

3TK28 (relay type) with spring-loaded terminals

3TK28 21 to 3TK28 24, 3TK28 30

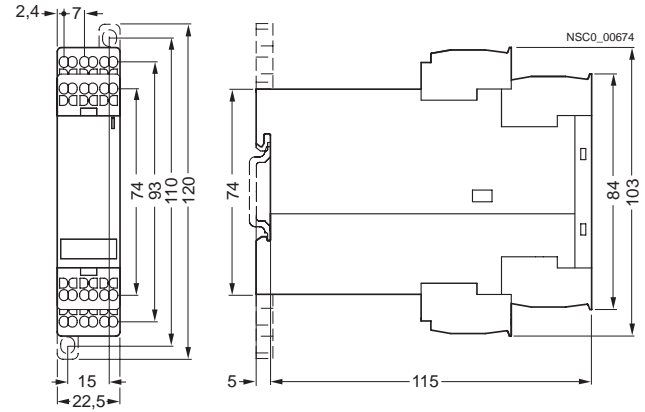

3TK28 25, 3TK28 27, 3TK28 28, 3TK28 34, 3TK28 35

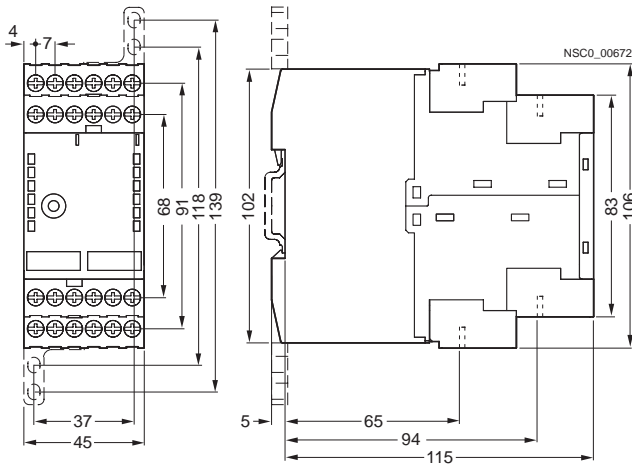

3TK28 25, 3TK28 27, 3TK28 28, 3TK28 34, 3TK28 35

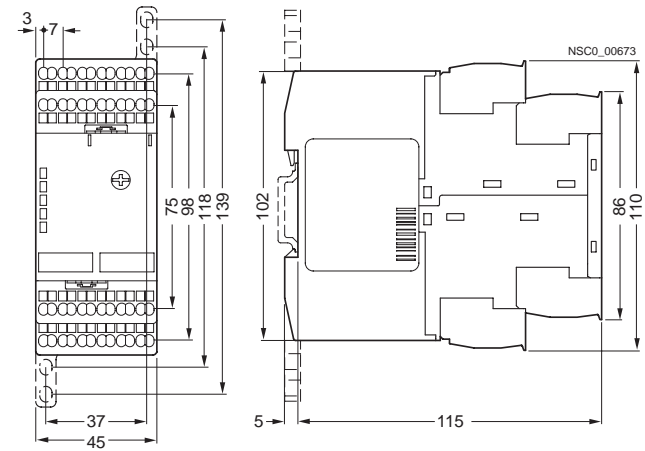

1) For 35 mm standard mounting rail acc. to EN 50022

3TK28 Safety Relays

With contactor relay enabling circuits

Overview

The SIRIUS safety pilot guides you quickly to the right device

Type	Connection		Crossover protection	Category acc. to EN 954-1					EMERGENCY-STOP	Protective door	Solid-state sensors	Cascading input 24 V DC	Safety mats
	1-channel	2-channel		B	1	2	3	4					
3TK28 50 basic unit	✓	✓	✓	✓	✓	✓	✓	--	✓	✓	--	--	--
3TK28 51 basic unit	✓	✓	✓	✓	✓	✓	✓	--	✓	✓	--	--	--
3TK28 52 basic unit	✓	✓	✓	✓	✓	✓	✓	--	✓	✓	--	--	--
3TK28 53 basic unit	✓	✓	✓	✓	✓	✓	✓	✓	✓	✓	✓	1	✓
3TK28 56 expansion unit	--	--	●	●	●	●	●	●	--	--	--	1	--
3TK28 57 expansion unit tv	--	--	●	●	●	●	●	●	--	--	--	1	--

Type	Enabling circuit, floating		Enabling circuit, solid-state		Signal-ing circuit	Autostart	Moni-tored start	Switching capacity		Rated operational voltage			Rated control supply voltage			Control inputs	
	Stop category 0	Stop category 1	Stop category 0	Stop category 1				AC-15 at U=230 V	DC-13 at U=24 V	24 V DC	230 V AC	600 V AC	24 V DC	115 V AC	230 V AC		24 V DC
3TK28 50 basic unit	3	--	--	--	--	✓	✓	6 A	10 A	✓	✓	✓	✓	✓	✓	✓	--
3TK28 51 basic unit	2	--	--	--	1 NC	✓	✓	6 A	10 A	✓	✓	✓	✓	✓	✓	✓	--
3TK28 52 basic unit	6	--	--	--	1 NC	✓	✓	6 A	10 A	✓	✓	✓	✓	✓	✓	✓	--
3TK28 53 basic unit	3	--	1	--	--	✓	✓	6 A	10 A	✓	✓	✓	✓	--	--	--	1
3TK28 56 expansion unit	6	--	1	--	1 NC	--	--	6 A	10 A	✓	✓	✓	✓	--	--	--	1
3TK28 57 expansion unit tv	--	3	1	--	--	--	--	6 A	10 A	✓	✓	✓	✓	--	--	--	1

✓ = available

-- = not available

● = corresponds to basic unit

Design

The solid-state safety combinations can be used in EMERGENCY-STOP devices according to EN 418 and in safety circuits according to EN 60204-1 (11.98), for example, for moving covers and protective doors. Depending on the device type and the external circuit, the maximum category that can be achieved is Category 4 of EN 954-1 or SIL 3 according to IEC 61508.

With these devices, solid-state safety relays are connected with contactor relays. The combination is supplied as a complete self-contained unit, fully wired up and tested, for snapping onto a standard mounting rail. This unit combines the advantages of a solid-state safety relay and those of contactor relays with positively-driven contacts in a single device. It has been certified by the appropriate authorities as a complete unit.

Basic units, Category 3

The solid-state safety relays 3TK28 50, 51 and 52 have two contactor relays snapped onto the safety solid-state unit as floating switch blocks. Three LEDs indicate the operating status and the function. During operation, all internal circuit elements are monitored cyclically for faults. Up to Category 3 according to EN 954-1 is achieved, depending on the external circuit.

Basic units, Category 4

The 3TK28 53 solid-state safety relay has two contactor relays snapped onto the safety solid-state units as floating switch blocks, as well as a safe solid-state output, a safe input for cascading and one input for normal switching duty. Three LEDs indicate the operating status and the function.

During start-up, the equipment runs through a self-test in which the internal electronics are checked for correct functioning.

During operation, all internal circuit elements are monitored cyclically for faults.

Expansion units and the 3TK28 30, 3TK28 56/57, 3RA7 11, 12, 13, 14 devices as well as external actuators or loads can be connected using the safe solid-state output (terminal 2). Cascading with the 3TK28 41/42/45/53 safety combinations as well as with the 3RA7 11 load feeder is also possible using the safe solid-state output (terminal 2).

Installation

For snap-on mounting on 35 mm standard mounting rail according to EN 50022. Screw fixing is also possible for the devices by means of 2 additional 3RP19 03 push-in lugs.

Function

The electronics (based on the example of a 3TK28 41)

- The internal circuit is configured with redundancy and diversity. The processors monitor each other dynamically.
- The output drivers are also redundant and diverse. They are monitored by a cyclic self-test.
- All sensor signals are dynamically tested. This enables faults to be detected on the sensors, wires (cross-circuit) etc.
- The field-effect transistor (FET) is switched by both processors. The output driver must be activated simultaneously by one of the two processors. Only then, the voltage is connected safely from power supply terminal A1 to output terminals 14 + 24.
- All solid-state switches (FET + output driver) are dynamically monitored by the processors.
- The required functionality (1-channel or 2-channel), monitored start or autostart, EMERGENCY-STOP, protective door and cascading is set by means of jumpers at the connection terminals.

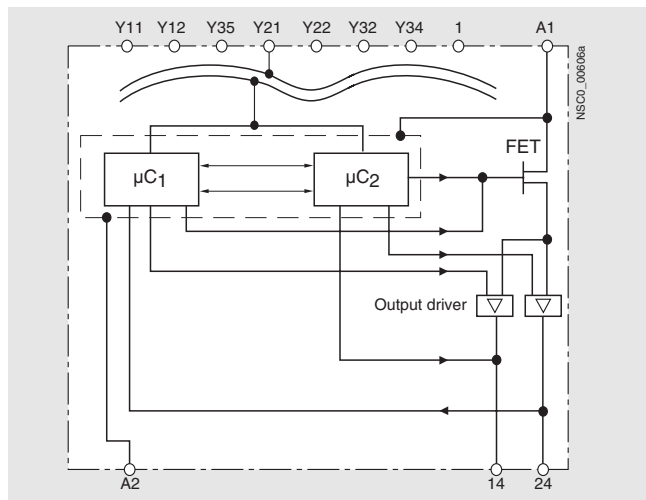

3TK28 Safety Relays

With contactor relay enabling circuits

Technical specifications

Type		3TK28 50	3TK28 51	3TK28 52	3TK28 53	3TK28 56	3TK28 57
Standards		EN 60204-1 (VDE 0113 Part 1), EN ISO 12100, EN 954-1, IEC 61508					
Category acc. to EN 954-1		3	3	3	4	As basic unit	As basic unit
Test certificates		TÜV, UL, CSA					
Rated insulation voltage U_i							
• For control circuit	V	50					
• For output contacts	V	690					
• For pollution severity		3					
Rated impulse withstand voltage U_{imp}							
• For control circuit	V	500					
• For output contacts	kV	6					
Coil operating range							
• AC operation		0.85 ... 1.1 × U_s					
• DC operation		0.9 ... 1.15 × U_s					
Coil ratings							
• DC/AC actuation at U_s	W	8.5					
Rated operational currents I_e							
acc. to IEC 60947-5-1							
• I_e / AC-15	at 230 V	A	6				
• I_e / DC-13	at 24 V	A	10 (auxiliary switch blocks: 6)				
Short-circuit protection (Weld-free protection at $I_K = 1$ kA)		See Chapter 3, 3RH1 Contactor Relays, Technical specifications					
Mechanical endurance		30 million operating cycles					
Electrical endurance		See Chapter 3, 3RH1 Contactor Relays, Characteristic curves					
Operating frequency z In operating cycles/h during normal duty	1/h	1000					
Response time							
• Monitored start	ms	200	200	200	60	--	--
• Autostart	ms	300	300	300	60	--	--
Release time							
• For EMERGENCY-STOP	ms	30	30	30	50	50	50 ¹⁾ / increments 0.05 ... 300 s
• For supply failure	ms	100	100	100	120	120	120
Recovery time							
• For EMERGENCY-STOP	ms	20	20	20	500	500	500
• For supply failure	s	0.02	0.02	0.02	7	7	7
Bridging of supply failures	ms	5	5	5	5	5	5
Minimum command duration							
• EMERGENCY-STOP	ms	20	20	20	30		
• ON button	ms	20	20	20	0.2 ... 5 s		
Simultaneity		∞					
Conductor cross-sections							
Screw-type connection							
• Finely stranded with end sleeve	mm ²	2 × (0.25 ... 1), 1 × (0.25 ... 2.5)					
• Solid	mm ²	2 × (0.2 ... 1), 1 × (0.2 ... 2.5)					
• Tightening torque	Nm	0.5 ... 0.6					
Spring-loaded terminals		(1 or 2 conductors can be connected)					
• Solid	mm ²	1 × (0.2 ... 2.5)					
• Finely stranded with end sleeve	mm ²	1 × (0.25 ... 2.5)					
• Finely stranded without end sleeve	mm ²	1 × (0.25 ... 2.5)					
• AWG conductors, solid or stranded		2 × AWG 24 ... 12					
Permissible ambient temperature							
• During operation	°C	-25 ... +60					
• During storage	°C	-40 ... +80					
Degree of protection acc. to EN 60529							
• Enclosures		IP40					
• Terminals		IP20					
Touch protection acc. to DIN VDE 0106 Part 100		Finger-safe					
Shock resistance							
• Sine wave	g/ms	8/10 and 15/5					
Permissible mounting position		Any					

1) For instantaneous output.

Dimensional drawings

3TK28 with floating enabling contacts, with auxiliary-contactor enabling contacts

3TK28 50, 3TK28 51, 3TK28 53, 3TK28 57
with screw-type terminals

3TK28 50, 3TK28 51, 3TK28 53, 3TK28 57
with spring-loaded terminals

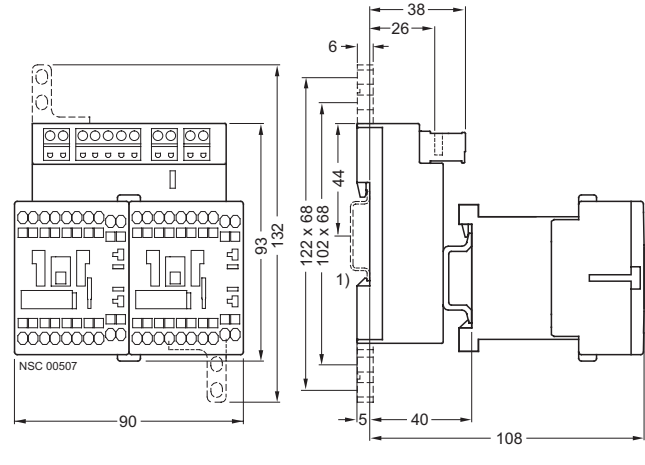
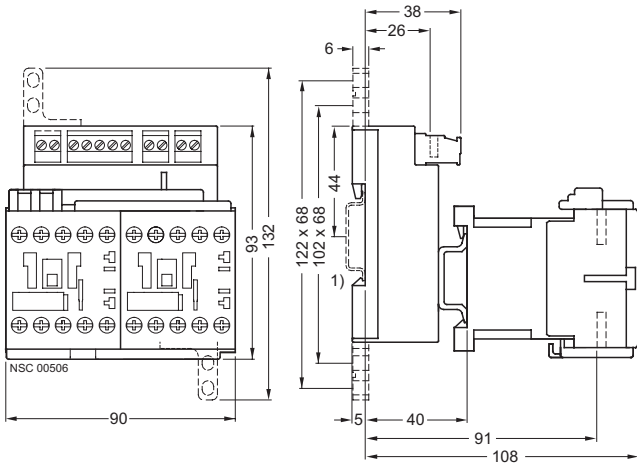

3TK28 52, 3TK28 56 with screw-type terminals

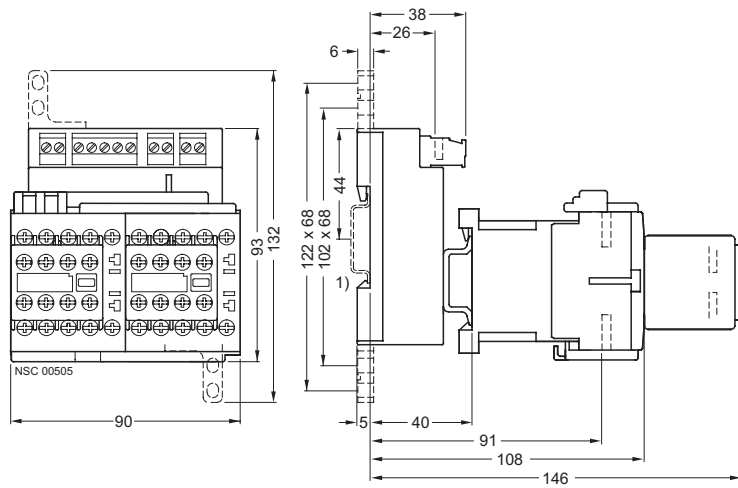

3TK28 52, 3TK28 56 with spring-loaded terminals

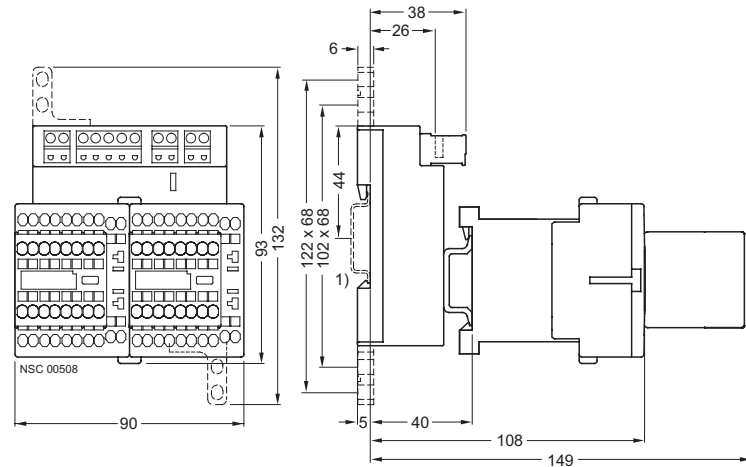

3RS17 interface converters

Overview

Interface converters perform the coupling function for analog signals on both the input side and the output side. They are indispensable when processing analog values with electronic controls. Under harsh industrial conditions in particular, it is often necessary to transmit analog signals over long distances. This means that electrical isolation is essential due to the different supply systems. The resistance of the wiring causes potential differences and losses which must be prevented.

Electromagnetic disturbance and overvoltages can affect the signals on the input side in particular or even destroy the analog modules. All terminals of the 3RS17 interface converters are safe up to a voltage of 30 V DC and protected against switching poles. Short-circuit protection is an especially important function for the outputs.

The devices are EMC-tested according to

- EN 50081 (basic technical standard for emitted interference)
- EN 61000-6-2 (basic technical standard for immunity to interference)

The analog signals comply with

- IEC 60381-1/2

Function

Active interface converters

Active interface converters provide maximum flexibility for the application by the use of an external supply voltage. Configuration with active interface converters is extremely easy because input and output resistances and voltage drops are compensated by the auxiliary supply. They support complete voltage isolation as well as conversion from one signal type to another or reinforcement. The load of the measured value transmitter is negligible.

Passive interface converters

Passive interface converters do not require an external supply voltage. This advantage can only be used by current signals that are converted 1:1. Reinforcement or conversion is not possible. The converters are used for complete electrical isolation of current signals and to protect the inputs and outputs. Passive isolators do not operate reaction-free, any load on the output produces an equal load on the input. When the passive converter is to be used, the output performance of the sensor and the input resistance of the analog input must be analyzed. This technique is being increasingly implemented in the case of pure current signals.

Calculation guide for passive converters

Note: Please note the following when using passive isolators:

The current-driving voltage of the measuring transducer U_E must be sufficient to drive the maximum current of 20 mA over the passive isolator with a voltage loss of $U_V = 2.7$ V and the load R_B .

This means that:

$$U_B \geq U_E = 2.7 \text{ V} + 20 \text{ mA} \times R_B$$

Distribution of the voltages in the case of passive isolators

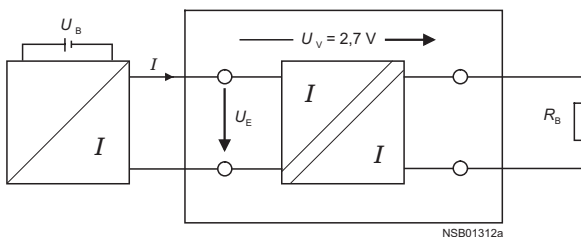

Input voltage depending on the load at $I_a = 20$ mA

The following diagram shows the input voltage U_E as a function of the load R_B taking into account the voltage loss U_V . If the load is known, the y-axis shows the minimum voltage that has to be supplied by the current source in order to drive the maximum current of 20 mA over the passive isolator and load.

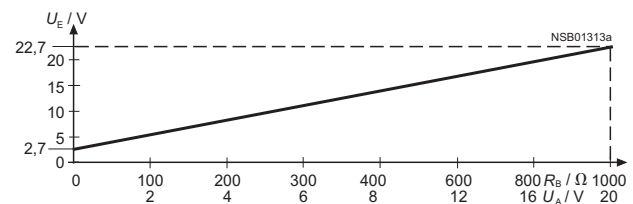

Current carrying capacity of the outputs

A maximum output resistance is specified for current signals. This resistance value specifies how large the input resistance of the next device connected in series can be as a result of the power of the converter.

For voltage signals, the maximum current that can be drawn from the output is the decisive factor.

2-way isolation

In the case of 2-way isolation, the input is galvanically isolated from the output. The "null potential" of the supply voltage is the same as the reference potential for the analog output signal.

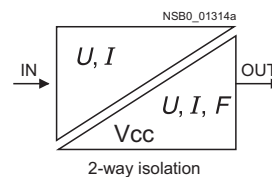

3-way isolation

For the 3-path isolation, each circuit is electrically isolated from the other circuits, i.e. input, output, and supply voltage do not have a potential connection.

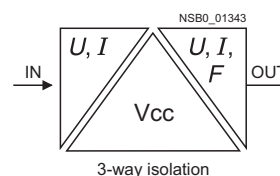

Technical specifications

Type 3RS17		24 V AC/DC	24 ... 240 V AC/DC
General data			
Supply voltage operating range	DC AC	0.7 ... 1.25 x U_n 0.8 ... 1.2 x U_n	0.7 ... 1.1 x U_n 0.8 ... 1.1 x U_n
Rated power	W	Typical 0.3	Typical 0.75
Electrical isolation of input/output		Active disconnecter: 1500 V, 50 Hz, 1 min; Passive disconnecter: 500 V, 50 Hz, 1 min	4000 V, 50 Hz, 1 min
Rated insulation voltage U_i pollution degree 2 Overvoltage category III acc. to DIN VDE 0100	V	50	300
Ambient temperature	During operation During storage	°C °C	-25 ... +60 -40 ... +85
Conductor cross-sections			
Screw terminals			
• Conductor cross-section			
- Solid	mm ²	1 x (0.25 ... 4)	
- Finely stranded with or without end sleeve	mm ²	1 x (0.5 ... 2.5)	
• Terminal screw		M3	
Spring-loaded terminal			
• Solid or finely stranded	mm ²	1 x (0.08 ... 2.5)	
• Finely stranded with end sleeve	mm ²	1 x (0.25 ... 1.5)	
Degree of protection	Enclosures IEC 529 Terminals IEC 529		IP30 IP20
Permissible mounting position			Any
Mounting onto standard rail EN 50022	mm		35
Vibration resistance IEC 68-2-6	Hz/mm		10-55/0.35
Shock resistance IEC 68-2-27	g/ms		15/11
Input			
Impedance	Voltage inputs Current inputs, active	kΩ Ω	330 100
Input voltage max.	Voltage inputs Current inputs, active	V V	30 AC/DC 30 AC/DC
Response current	Current inputs, passive	μA	100/250 (6.2 mm width)
Voltage drop	Current inputs, passive	V	2.7 at 20 mA
Output			
Impedance	Voltage output, 0 ... 10 V	Ω	55
Output load	Current 0/4 ... 20 mA active, max. Current 0 ... 20 mA passive, max. Frequency, min.	Ω Ω Ω	400 1000 at 20 mA, 400 at 20 mA (6.2 mm width) 2.400
Output voltage	Frequency	V	20.9
Output current for supply voltage	Voltage output 0 ... 10 V, max. Frequency, max.	mA mA	21 10
Short-circuit current	Voltage output, 0 ... 10 V Current output, 0 ... 20 mA, passive Frequency	mA mA mA	40 Corresponds to the input current 15
Protection of the outputs			Short-circuit resistant
Max. overvoltage at output		V	30
Accuracy			
Total error at 23 °C	Active disconnecter (frequency) Active disconnecter (U, I)	% %	0.1 0.1 ¹⁾
Linearity error	Active disconnecter (U, I) Active disconnecter (frequency)	% %	0.02 0.02
Deviation due to ambient temperature	Active disconnecter (frequency) Active disconnecter (U, I) Passive disconnecter		0 ... 50 Hz: 7.5 mHz/K; 0 ... 100 Hz: 15 mHz/K; 0 ... 1 kHz: 0.15 Hz/K; 0 ... 10 kHz: 1.5 Hz/K 0 ... 10 V: 1.5 mV/K; 0/4 ... 20 mA: 3 μA/K Width 6.2 mm: 100 ppm/K of measured value Width 12.5 mm: with load < 600 Ω: < 50 ppm/K of measured value; with load ≥ 600 Ω: < 175 ppm/K of measured value
Transmission error	Passive disconnecter	%	0.1
Measured value load error		%/Ω	0.06/100
Limit frequency at 3 dB	Active disconnecter (frequency) Active disconnecter (U, I) Passive disconnecter	Hz Hz Hz	30 30 50
Rise time (10 to 90 %)	Active disconnecter (frequency) Active disconnecter (U, I)	 ms	 10 + 1 period 10
Settling time at 1 % accuracy	Active disconnecter (frequency) Active disconnecter (U, I)	 ms	 30 + 1 period 30
Residual ripple	Active disconnecter (U, I) Passive disconnecter	mV _{eff} mV _{eff}	< 5 < 8

The accuracy refers to the measurement range end value if not otherwise stated.

1) For 3RS17 06: 0.1 % for selected output 4 ... 20 mA; 0.3 % for selected output 0 ... 20 mA; 0.3 % for selected output 0 ... 10 V and from an input

voltage > 50 mV. For an input voltage < 50 mV, an offset of max. 20 ms is effective at the output.

3RS17 interface converters

Dimensional drawings

6.2 mm design

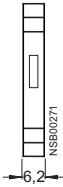

12.5 mm design

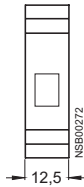

17.5 mm design

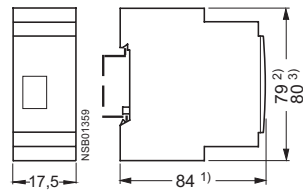

- 1) Width for 3RS17 25 is approx. 90 mm.
- 2) Dimensions for screw-type connection.
- 3) Dimensions for spring-loaded terminal.

Schematics

3RS17 00-..D..
3RS17 02-..D..
3RS17 03-..D..
3RS17 05-..D..

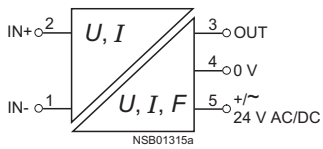

3RS17 06-..FD00

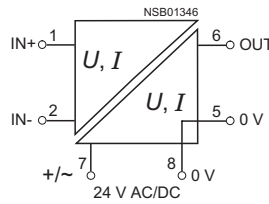

3RS17 06-..FE00

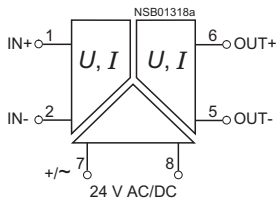

3RS17 0-..W00

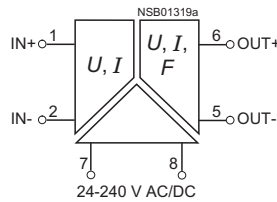

3RS17 25-..FD00

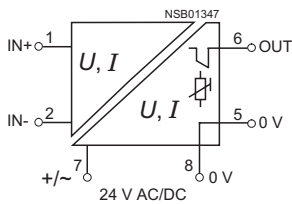

3RS17 25-..FW00

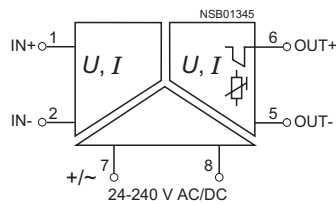

3RS17 20-..ET00

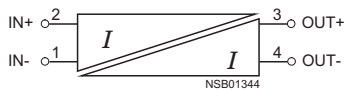

3RS17 21-..ET00

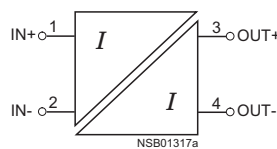

3RS17 22-..ET00

